

## SUPER LOW ON RESISTANCE / LOW VOLTAGE 1A LDO

NO.EA-122-070627

### OUTLINE

The R1172x Series are CMOS-based positive voltage regulator ICs. The R1172x Series have features of super low dropout, 1A output current capability. Even the output voltage is set at 1.5V, on resistance of internal FET is typically 0.32Ω. Therefore, applications that require a large current at small dropout are suitable for the R1172x series. Low input voltage is acceptable and low output voltage can be set. The minimum input voltage is 1.4V, and the lowest set output voltage is 0.8V. Each of these ICs consists of a voltage reference unit, an error amplifier, resistor net for setting output voltage, a current limit circuit at over-current, a chip enable circuit, a thermal-shutdown circuit, and so on. A stand-by mode with ultra low consumption current can be realized with the chip enable pin. The output voltage of R1172 is fixed in the IC.

Since the packages for these ICs are SOT-23-5, SOT-89-5, HSON-6, and HSOP-6J with high power dissipation, high density mounting of the ICs on boards is possible.

### FEATURES

- Output Current ..... 1A
- Supply Current ..... Typ. 60μA
- Standby Current ..... Typ. 0.1μA
- Input Voltage Range ..... 1.4V to 6.0V
- Output Voltage..... Stepwise setting with a step of 0.1V in the range of 0.8V to 5.0V (Exceptions: HSOP-6J = 0.8V to 3.5V)
- Dropout Voltage..... Typ. 0.32V (V<sub>OUT</sub>=1.5V, I<sub>OUT</sub>=1A)  
Typ. 0.18V (V<sub>OUT</sub>=2.8V, I<sub>OUT</sub>=1A)
- Ripple Rejection ..... Typ. 70dB (V<sub>OUT</sub>=2.8V)
- Output Voltage Accuracy ..... ±2.0%
- Temperature-Drift Coefficient of Output Voltage ..... Typ. ±100ppm/°C
- Line Regulation ..... Typ. 0.05%/V
- Load Regulation ..... Typ. 15mV at I<sub>OUT</sub>=300mA, Typ. 50mV at I<sub>OUT</sub>=1A
- Packages ..... SOT-23-5, SOT-89-5, HSON-6, HSOP-6J
- Built-in Inrush current limit circuit ..... Typ. 500 mA
- Built-in Fold-Back Protection Circuit ..... Typ. 250mA (Current at short mode)
- Built-in Thermal Shutdown Circuit ..... Thermal Shutdown Temperature ; Typ. 150°C  
Released Temperature ; Typ. 120°C
- Built-in Auto Discharge Function ..... D version
- Output capacitors ..... C<sub>IN</sub>=C<sub>OUT</sub>=Tantalum 4.7μF (V<sub>OUT</sub> < 1.0V)  
C<sub>IN</sub>=C<sub>OUT</sub>=Ceramic 4.7μF (V<sub>OUT</sub> ≥ 1.0V)

### APPLICATIONS

- Local Power source for Notebook PC.
- Local Power source for portable communication equipments, cameras, and VCRs.
- Local Power source for home appliances.

## BLOCK DIAGRAMS

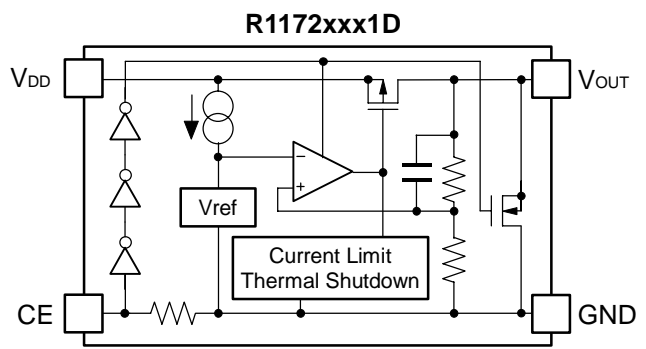
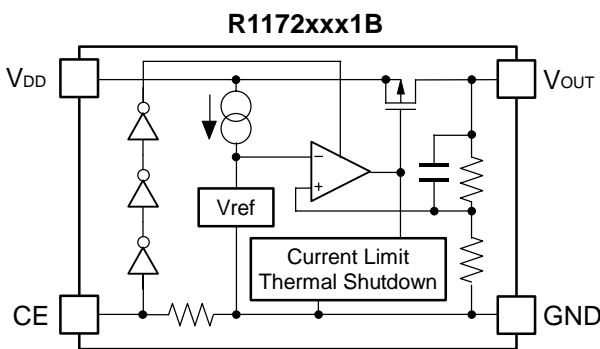
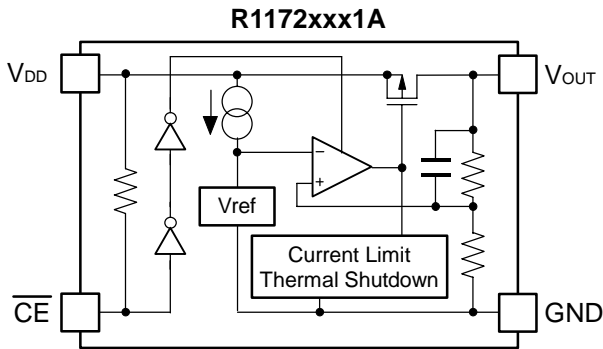

## SELECTION GUIDE

The output voltage, auto discharge function\*, and the package type for the ICs can be selected at the user's request. The selection can be made with designating the part number as shown below;

R1172xxx1x-xx-x ←Part Number  
 ↑ ↑ ↑ ↑ ↑  
 a b c d e

Code	Contents
a	Designation of Package Type; N: SOT-23-5, H: SOT-89-5, D: HSON-6, S: HSOP-6J
b	Setting Output Voltage ( $V_{OUT}$ ); Stepwise setting with a step of 0.1V in the range of 0.8V to 5.0V (HSOP-6J : 0.8V to 3.5V) is possible. Exceptions; 1.85V output: R1172x181x5-xx-x, 2.85V output: R1172x281x5-xx-x
c	Designation of option; A: active low, without auto discharge function* B: active high, without auto discharge function* D: active high, with auto discharge function*
d	Designation of Taping Type; T1 (SOT-89-5), TR (SOT-23-5, HSON-6), E2 (HSOP-6J) Refer to Taping Specifications.
e	Designation of composition of pin plating; -F: Lead free plating

\*) When the mode is into standby with CE signal, auto discharge transistor turns on, and it makes the turn-off speed faster than normal type.

## PIN CONFIGURATIONS

### ● SOT-23-5

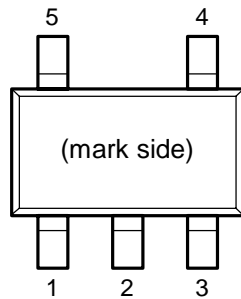

### ● SOT-89-5

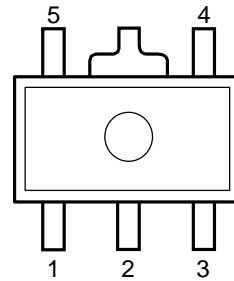

### ● HSON-6

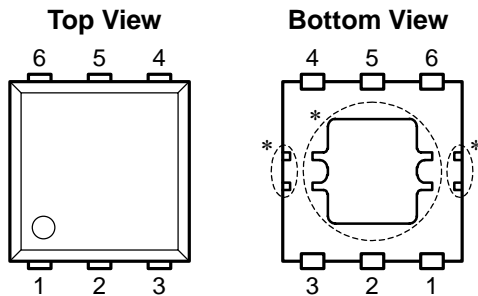

### ● HSOP-6J

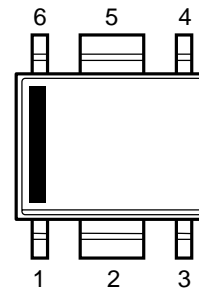

## PIN DESCRIPTIONS

### ● SOT-23-5

Pin No.	Symbol	Description
1	$V_{OUT}$	Voltage Regulator Output Pin
2	GND	Ground Pin
3	$V_{DD}$	Input Pin
4	NC	No Connection
5	$\overline{CE}$ or CE	Chip Enable Pin

### ● SOT-89-5

Pin No.	Symbol	Description
1	$\overline{CE}$ or CE	Chip Enable Pin
2	GND	Ground Pin
3	NC	No Connection
4	$V_{DD}$	Input Pin
5	$V_{OUT}$	Voltage Regulator Output Pin

### ● HSON-6\*1

Pin No.	Symbol	Description
1	$V_{OUT}^{*2}$	Voltage Regulator Output Pin
2	$V_{OUT}^{*2}$	Voltage Regulator Output Pin
3	$\overline{CE}$ or CE	Chip Enable Pin
4	GND	Ground Pin
5	$V_{DD}$	Input Pin
6	$V_{DD}$	Input Pin

### ● HSOP-6J

Pin No.	Symbol	Description
1	$V_{OUT}$	Voltage Regulator Output Pin
2	GND	Ground Pin
3	$\overline{CE}$ or CE	Chip Enable Pin
4	NC	No Connection
5	GND	Ground Pin
6	$V_{DD}$	Input Pin

\*1) Tab in the  parts have GND level. (They are connected to the reverse side of this IC.)

Do not connect to other wires or land patterns.

\*2) Connect Pin1 and Pin2 as short as possible.

## ABSOLUTE MAXIMUM RATINGS

Symbol	Item	Rating	Unit
$V_{IN}$	Input Voltage	6.5	V
$V_{CE}$	Input Voltage ( $\overline{CE}$ or CE Input Pin)	-0.3 to 6.5	V
$V_{OUT}$	Output Voltage	-0.3 to $V_{IN}+0.3$	V
$I_{OUT}$	Output Current	1.4	A
$P_D$	Power Dissipation (SOT-23-5) *	420	mW
	Power Dissipation (SOT-89-5) *	900	
	Power Dissipation (HSOP-6) *	900	
	Power Dissipation (HSOP-6J) *	1700	
$T_{opt}$	Operating Temperature Range	-40 to 85	°C
$T_{stg}$	Storage Temperature Range	-55 to 125	°C

\*) For Power Dissipation, please refer to PACKAGE INFORMATION to be described.  
 (Includes additional information of High Wattage Land Pattern)

## ELECTRICAL CHARACTERISTICS

### • R1172xxx1A

 $T_{opt}=25^{\circ}\text{C}$ 

Symbol	Item	Conditions	Min.	Typ.	Max.	Unit
$V_{IN}$	Input Voltage		1.4		6.0	V
$I_{SS}$	Supply Current	$V_{IN}-V_{OUT}=1.0\text{V}$ , $V_{CE}=0\text{V}$ , $I_{OUT}=0\text{A}$		60	100	$\mu\text{A}$
$I_{standby}$	Standby Current	$V_{IN}=6.0\text{V}$ , $V_{CE}=V_{IN}$		0.1	1.0	$\mu\text{A}$
$V_{OUT}$	Output Voltage	$V_{IN}-V_{OUT}=1.0\text{V}$ $I_{OUT}=100\text{mA}$	$V_{OUT} > 1.5\text{V}$	$\times 0.98$	$\times 1.02$	V
			$V_{OUT} \leq 1.5\text{V}$	-30	+30	mV
$I_{OUT}$	Output Current	$V_{IN}-V_{OUT}=1.0\text{V}$	1			A
$\frac{\Delta V_{OUT}}{\Delta I_{OUT}}$	Load Regulation	$V_{IN}-V_{OUT}=0.3\text{V}$ $1\text{mA} \leq I_{OUT} \leq 300\text{mA}$ If $V_{OUT} \leq 1.1\text{V}$ , then $V_{IN}=1.4\text{V}$	-15	15	30	mV
		$V_{IN}-V_{OUT}=0.3\text{V}$ $1\text{mA} \leq I_{OUT} \leq 1\text{A}$ If $V_{OUT} \leq 1.1\text{V}$ , then $V_{IN}=1.7\text{V}$		50		
$V_{DIF}$	Dropout Voltage	Refer to Dropout Voltage Table				
$\frac{\Delta V_{OUT}}{\Delta V_{IN}}$	Line Regulation	$I_{OUT}=100\text{mA}$ $V_{OUT}+0.5\text{V} \leq V_{IN} \leq 6.0\text{V}$ If $V_{OUT} \leq 0.9\text{V}$ , $1.4\text{V} \leq V_{IN} \leq 6.0\text{V}$		0.05	0.20	%/V
RR	Ripple Rejection	$f=1\text{kHz}$ ( $V_{OUT} \leq 4.0\text{V}$ ) $f=1\text{kHz}$ ( $V_{OUT} > 4.0\text{V}$ ) Ripple $0.5\text{Vp-p}$ , $V_{IN}-V_{OUT}=1.0\text{V}$ , $I_{OUT}=100\text{mA}$ If $V_{OUT} \leq 1.2\text{V}$ , $V_{IN}-V_{OUT}=1.5\text{V}$ , $I_{OUT}=100\text{mA}$		70 60		dB
$\frac{\Delta V_{OUT}}{\Delta T_{opt}}$	Output Voltage Temperature Coefficient	$I_{OUT}=100\text{mA}$ $-40^{\circ}\text{C} \leq T_{opt} \leq 85^{\circ}\text{C}$		$\pm 100$		ppm/ $^{\circ}\text{C}$
$I_{lim}$	Short Current Limit	$V_{OUT}=0\text{V}$		250		mA
$R_{PU}$	Pull-up Resistance for $\overline{\text{CE}}$ pin		1.9	5.0	15.0	$\text{M}\Omega$
$V_{CEH}$	$\overline{\text{CE}}$ Input Voltage "H"		1.0		6.0	V
$V_{CEL}$	$\overline{\text{CE}}$ Input Voltage "L"		0		0.4	V
$T_{TSD}$	Thermal Shutdown Temperature	Junction Temperature		150		$^{\circ}\text{C}$
$T_{TSR}$	Thermal Shutdown Released Temperature	Junction Temperature		120		$^{\circ}\text{C}$
en	Output Noise	$\text{BW}=10\text{Hz to }100\text{kHz}$		30		$\mu\text{Vrms}$

## R1172x

### • R1172xxx1B/D

T<sub>opt</sub>=25°C

Symbol	Item	Conditions	Min.	Typ.	Max.	Unit	
V <sub>IN</sub>	Input Voltage		1.4		6.0	V	
I <sub>SS</sub>	Supply Current	V <sub>IN</sub> -V <sub>OUT</sub> =1.0V, V <sub>IN</sub> =V <sub>CE</sub> , I <sub>OUT</sub> =0A		60	100	μA	
I <sub>standby</sub>	Standby Current	V <sub>IN</sub> = 6.0V, V <sub>CE</sub> =0V		0.1	1.0	μA	
V <sub>OUT</sub>	Output Voltage	V <sub>IN</sub> -V <sub>OUT</sub> =1.0V I <sub>OUT</sub> =100mA	V <sub>OUT</sub> > 1.5V	×0.98		×1.02	V
			V <sub>OUT</sub> ≤ 1.5V	-30		+30	mV
I <sub>OUT</sub>	Output Current	V <sub>IN</sub> -V <sub>OUT</sub> =1.0V	1			A	
ΔV <sub>OUT</sub> / ΔI <sub>OUT</sub>	Load Regulation	V <sub>IN</sub> -V <sub>OUT</sub> =0.3V 1mA ≤ I <sub>OUT</sub> ≤ 300mA If V <sub>OUT</sub> ≤ 1.1V, then V <sub>IN</sub> =1.4V	-15	15	30	mV	
		V <sub>IN</sub> -V <sub>OUT</sub> =0.3V 1mA ≤ I <sub>OUT</sub> ≤ 1A If V <sub>OUT</sub> ≤ 1.1V, then V <sub>IN</sub> =1.7V		50			
V <sub>DIF</sub>	Dropout Voltage	Refer to Dropout Voltage Table					
ΔV <sub>OUT</sub> / ΔV <sub>IN</sub>	Line Regulation	I <sub>OUT</sub> =100mA V <sub>OUT</sub> +0.5V ≤ V <sub>IN</sub> ≤ 6.0V If V <sub>OUT</sub> ≤ 0.9V, 1.4V ≤ V <sub>IN</sub> ≤ 6.0V		0.05	0.20	%/V	
RR	Ripple Rejection	f=1kHz (V <sub>OUT</sub> ≤ 4.0V) f=1kHz (V <sub>OUT</sub> > 4.0V) Ripple 0.5Vp-p, V <sub>IN</sub> -V <sub>OUT</sub> =1.0V I <sub>OUT</sub> =100mA If V <sub>OUT</sub> ≤ 1.2V, V <sub>IN</sub> -V <sub>OUT</sub> =1.5V, I <sub>OUT</sub> =100mA		70 60		dB	
ΔV <sub>OUT</sub> / ΔT <sub>opt</sub>	Output Voltage Temperature Coefficient	I <sub>OUT</sub> =100mA -40°C ≤ T <sub>opt</sub> ≤ 85°C		±100		ppm/°C	
I <sub>lim</sub>	Short Current Limit	V <sub>OUT</sub> =0V		250		mA	
R <sub>PD</sub>	Pull-down Resistance for CE pin		1.9	5.0	15.0	MΩ	
V <sub>CEH</sub>	CE Input Voltage "H"		1.0		6.0	V	
V <sub>CEL</sub>	CE Input Voltage "L"		0		0.4	V	
T <sub>TSD</sub>	Thermal Shutdown Temperature	Junction Temperature		150		°C	
T <sub>TSR</sub>	Thermal Shutdown Released Temperature	Junction Temperature		120		°C	
en	Output Noise	BW=10Hz to 100kHz		30		μVrms	

## • Dropout Voltage by Output Voltage

T<sub>opt</sub>=25°C

Output Voltage V <sub>OUT</sub> (V)	Dropout Voltage V <sub>DIF</sub> (V)		
	I <sub>OUT</sub> =300mA		I <sub>OUT</sub> =1A
	Typ.	Max.	Typ.
0.8 ≤ V <sub>OUT</sub> < 0.9	0.33	0.57	0.72
0.9 ≤ V <sub>OUT</sub> < 1.0	0.22	0.47	0.64
1.0 ≤ V <sub>OUT</sub> < 1.5	0.18	0.32	0.56
1.5 ≤ V <sub>OUT</sub> < 2.6	0.10	0.15	0.32
2.6 ≤ V <sub>OUT</sub>	0.05	0.10	0.18

## TYPICAL APPLICATION (R1172xxx1B/D)

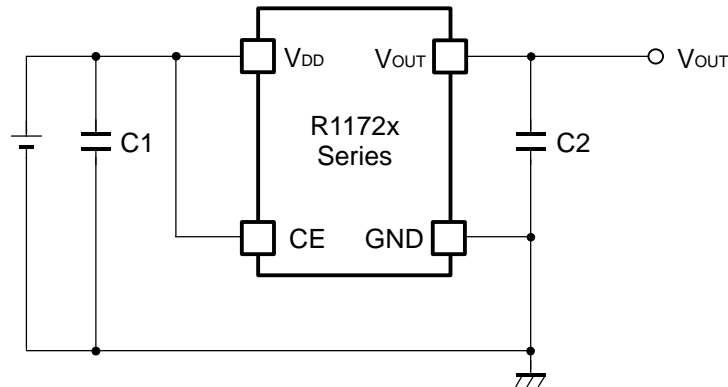

## TECHNICAL NOTES

When using these ICs, consider the following points:

### Phase Compensation

In these ICs, phase compensation is made for securing stable operation even if the load current is varied. For this purpose, use a capacitor C2 with good frequency characteristics and ESR (Equivalent Series Resistance).

The recommendation value is as follows.

Output Voltage	C2 recommendation value	Components Recommendation	
$V_{OUT} < 1.0V$	Tantalum 4.7 $\mu$ F or more		
$1.0 \leq V_{OUT} \leq 3.3V$	Ceramic 4.7 $\mu$ F or more	Kyocera 4.7 $\mu$ F (1608) Murata 4.7 $\mu$ F (1608) Murata 10 $\mu$ F (1608)	Part Number : CM105X5R475M06AB Part Number : GRM188R60J475KE19B Part Number : GRM188B30G106ME46B
$3.3V < V_{OUT}$	Ceramic 4.7 $\mu$ F or more	Kyocera 4.7 $\mu$ F (thin 2012) Murata 10 $\mu$ F (2012)	Part Number : CT21X5R475M06AB Part Number : GRM21BB30J106K

\* If you use a tantalum type capacitor and ESR value of the capacitor is large, output might be unstable. Evaluate your circuit with considering frequency characteristics.

\* Depending on the capacitor size, manufacturer, and part number, the bias characteristics and temperature characteristics are different. Evaluate the circuit with actual using capacitors.

### PCB Layout

Make  $V_{DD}$  and GND lines sufficient. If their impedance is high, noise pickup or unstable operation may result. Connect a capacitor C1 with a capacitance value as much as 4.7 $\mu$ F or more between  $V_{DD}$  and GND pin, and as close as possible to the pins.

Set external components, especially the output capacitor C2, as close as possible to the ICs, and make wiring as short as possible.



## TYPICAL CHARACTERISTICS

### 1) Output Voltage vs. Output Current (Topt=25°C)

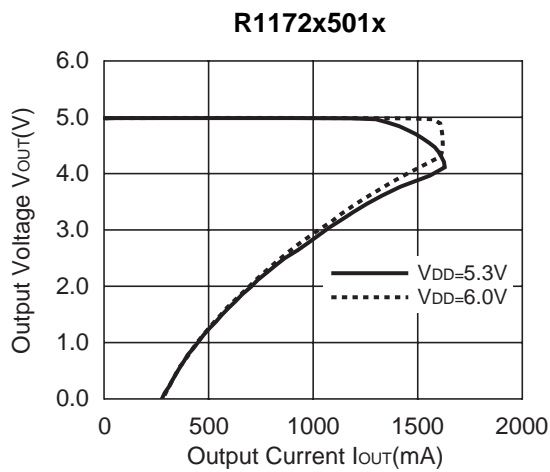
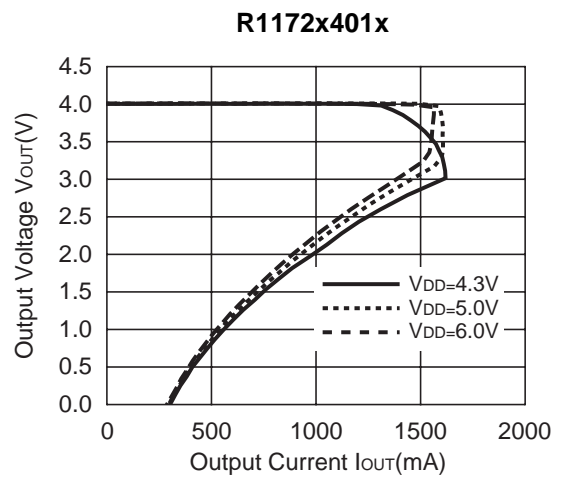
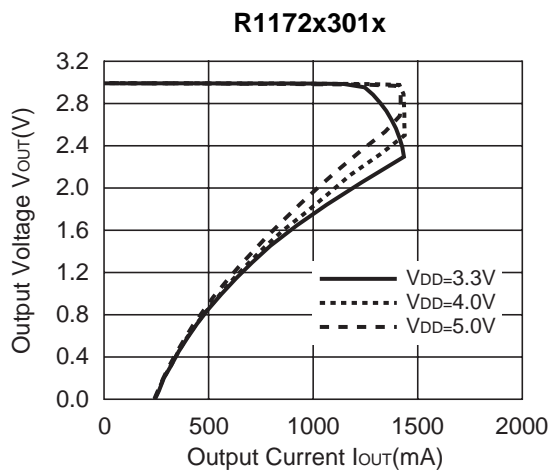
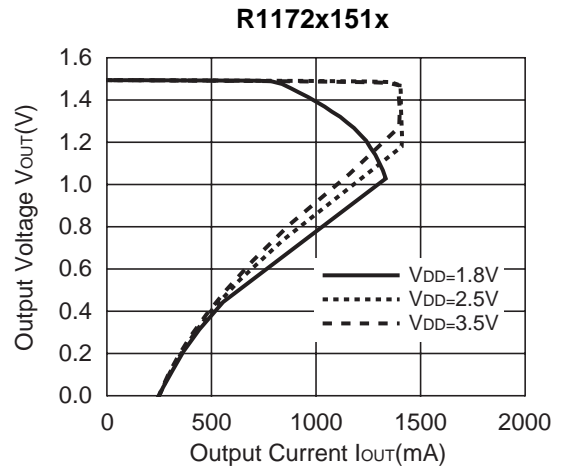
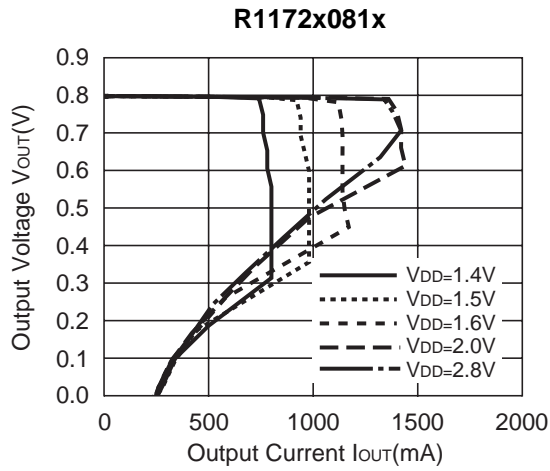

2) Output Voltage vs. Input Voltage (T<sub>opt</sub>=25°C)

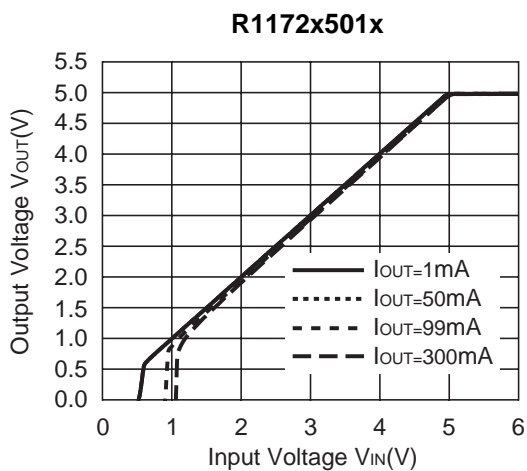
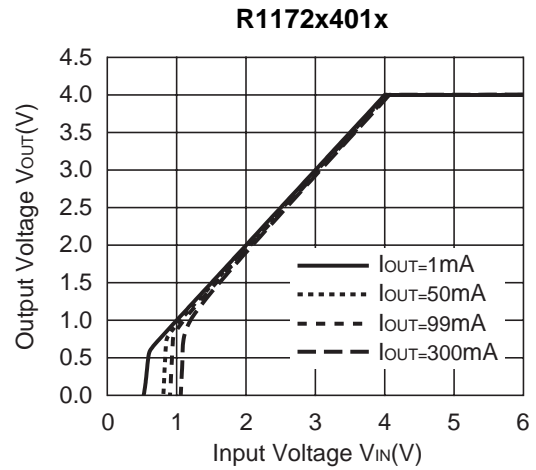
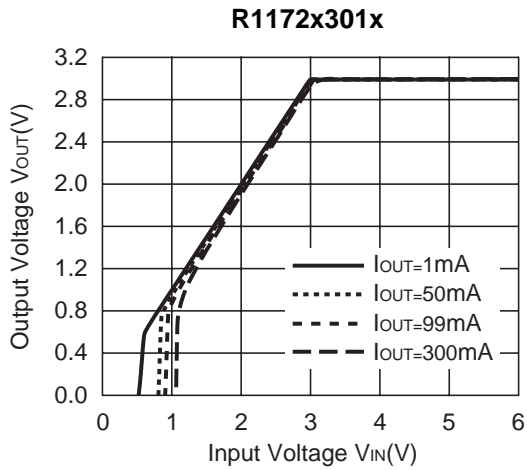
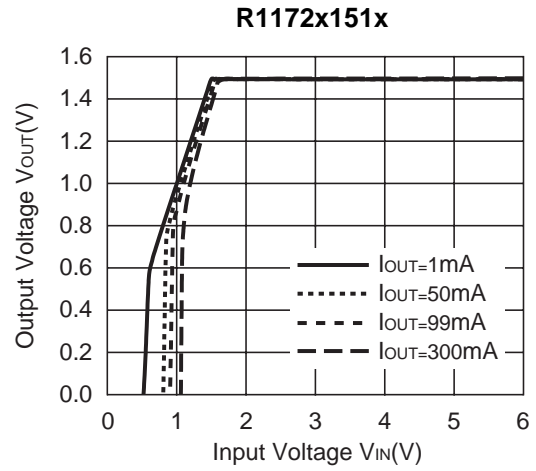
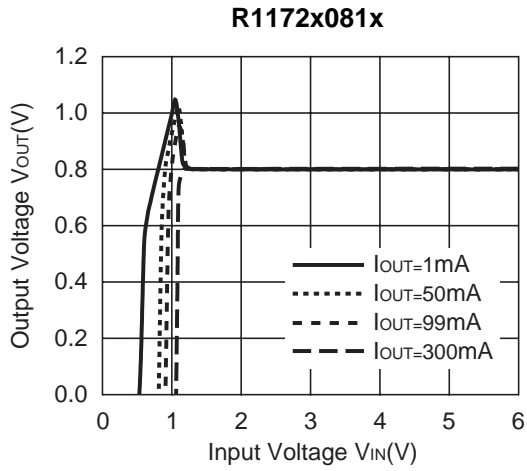

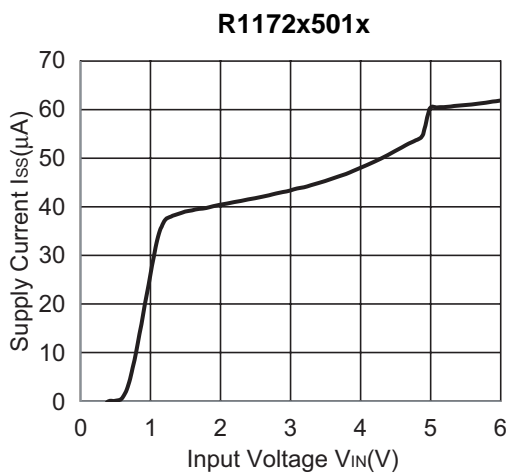
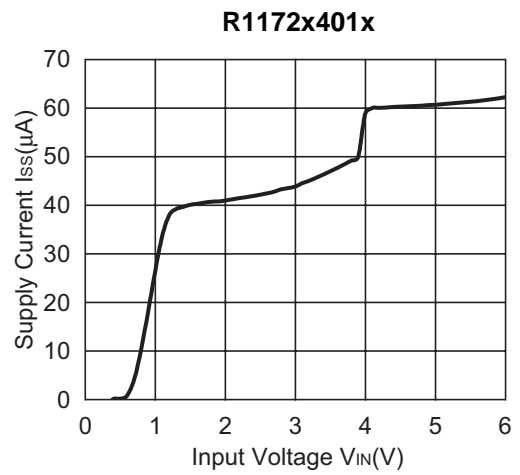
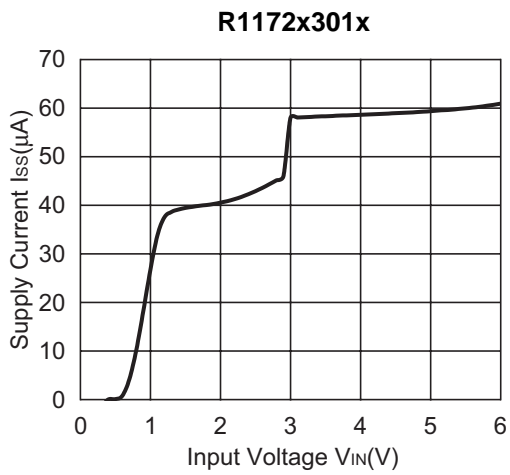
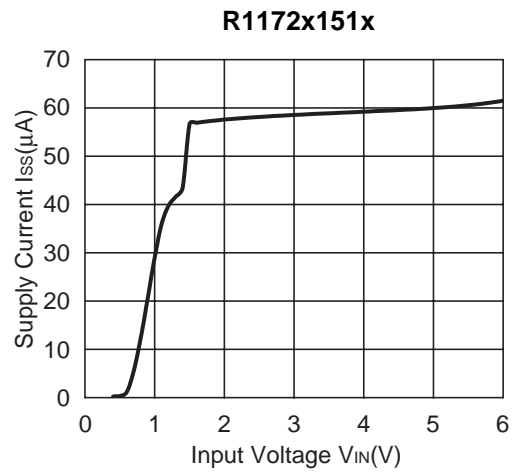
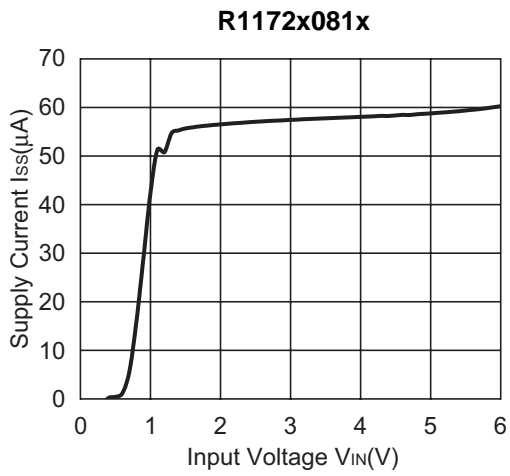
3) Supply Current vs. Input Current (T<sub>opt</sub>=25°C)

4) Output Voltage vs. Temperature ( $I_{OUT}=100mA$ )

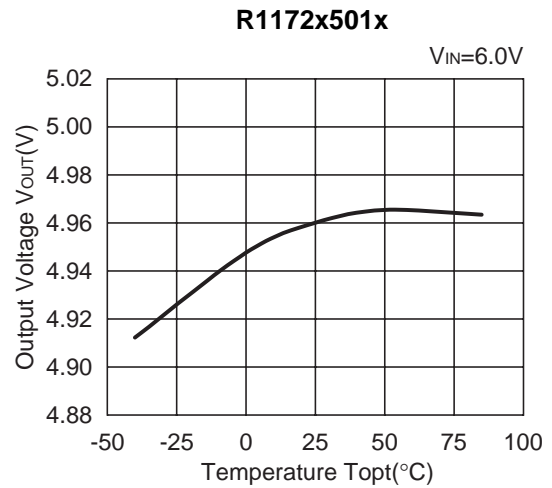
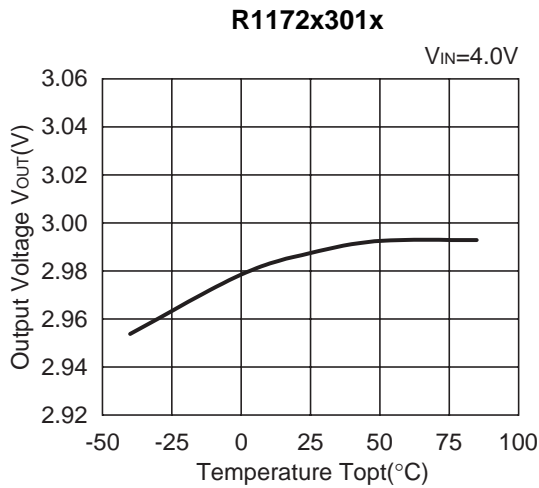
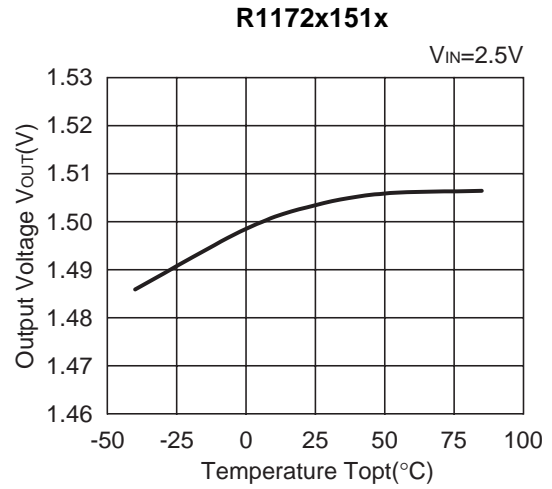
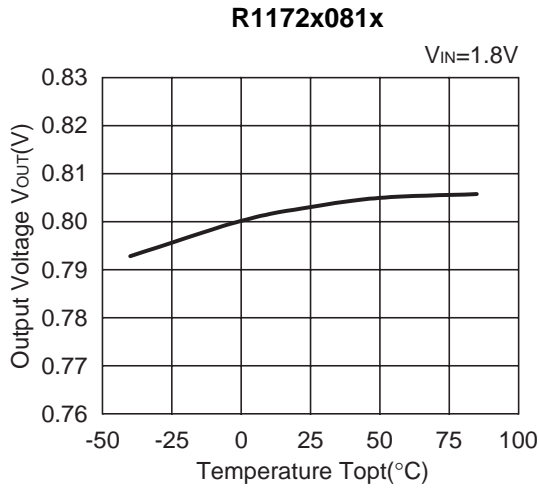

5) Supply Current vs. Temperature

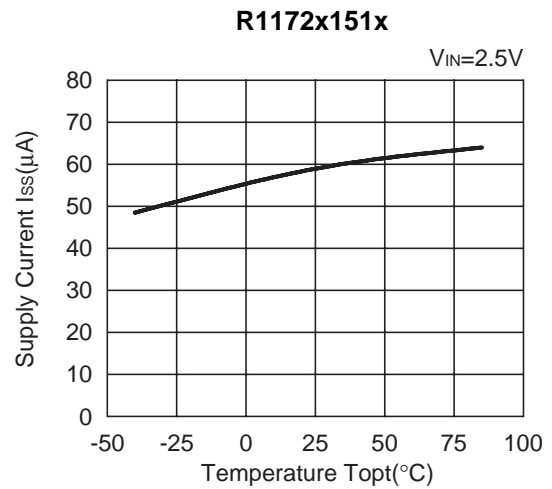
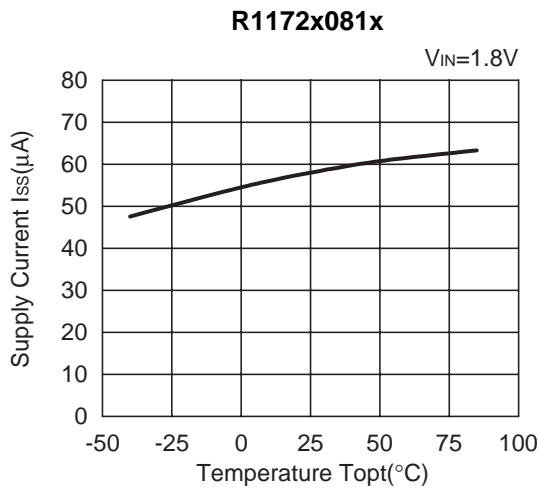

R1172x301x

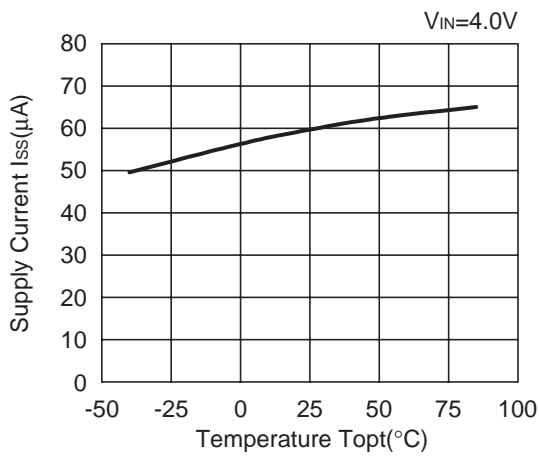

R1172x501x

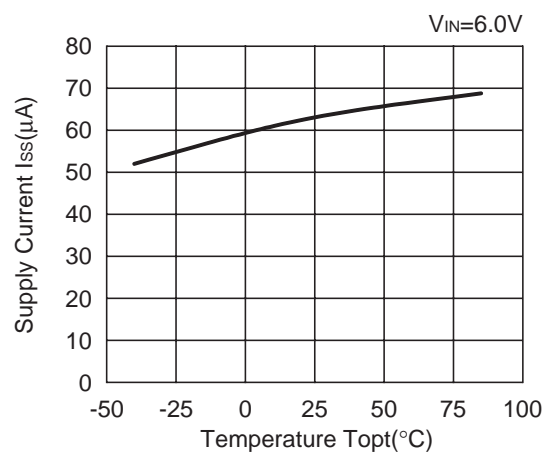

6) Dropout Voltage vs. Output Current

R1172x081x

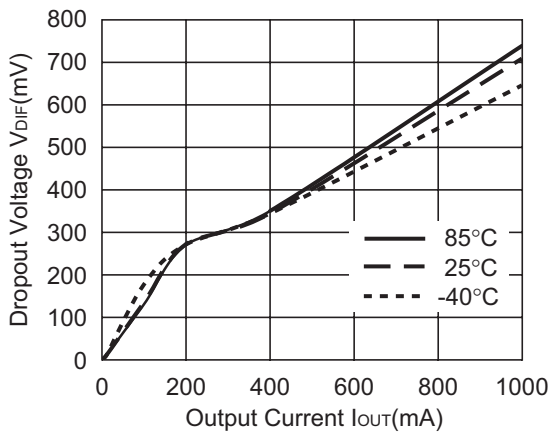

R1172x091x

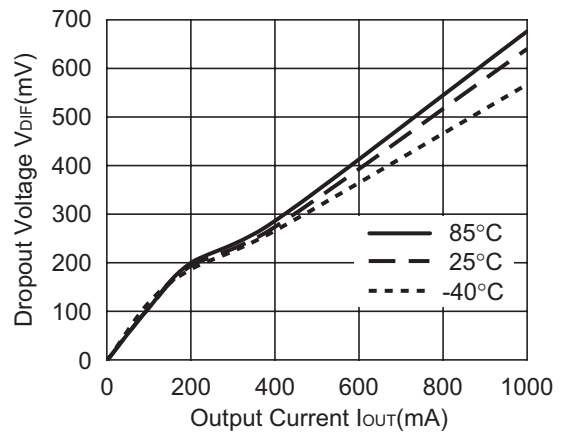

R1172x101x

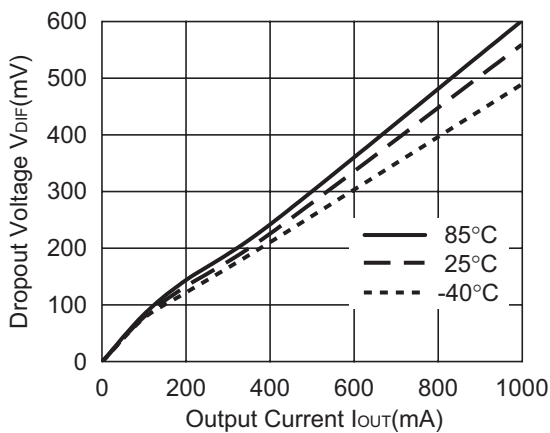

R1172x151x

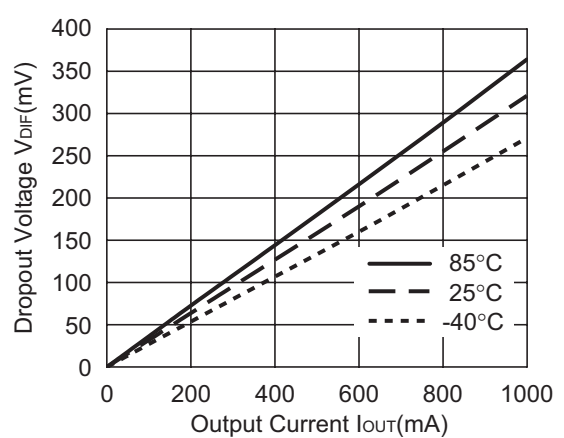

R1172x301x

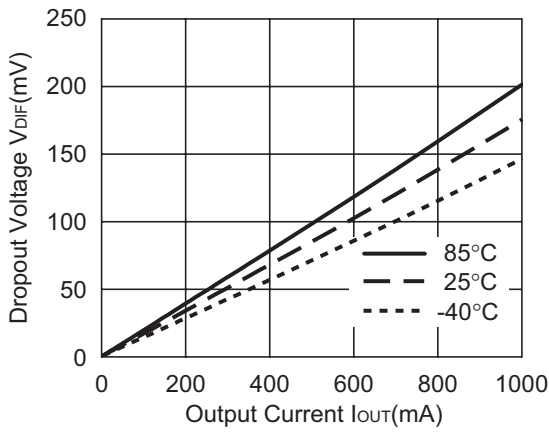

R1172x501x

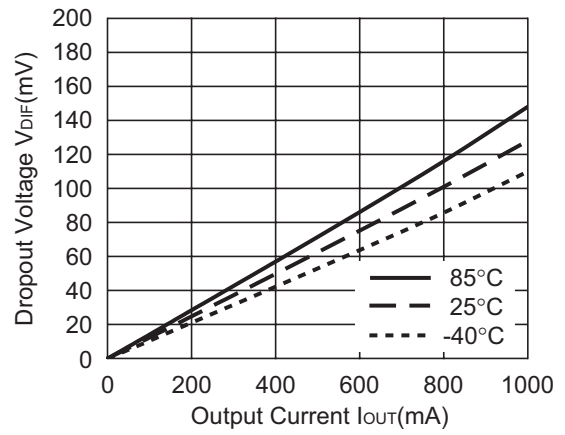

7) Dropout Voltage vs. Set Output Voltage

R1172xxx1x

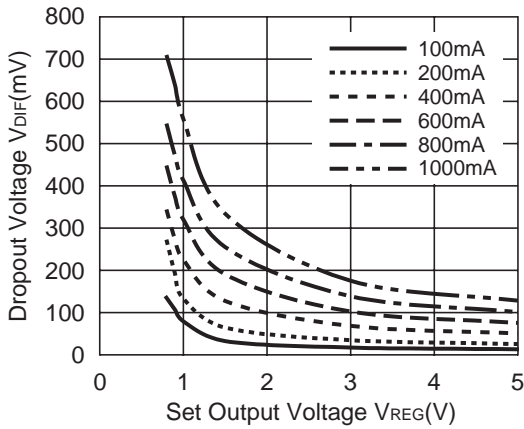

8) 0.8V Output type, Operating Input Voltage Range

R1172x081x

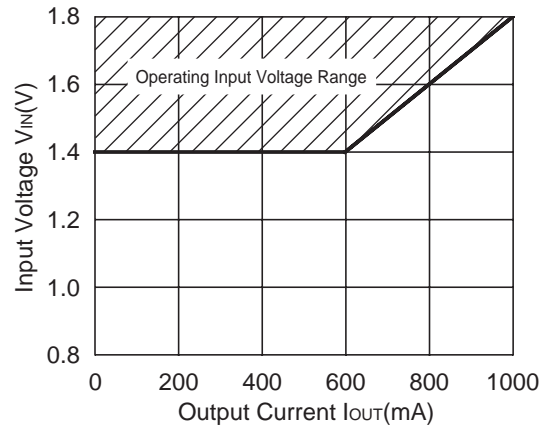

9) Ripple Rejection vs. Input Bias

R1172x301x

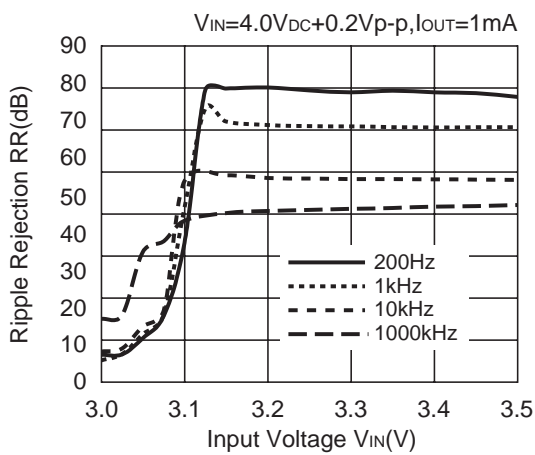

R1172x301x

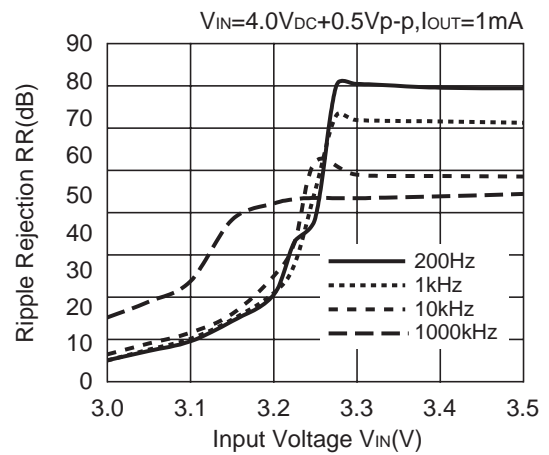

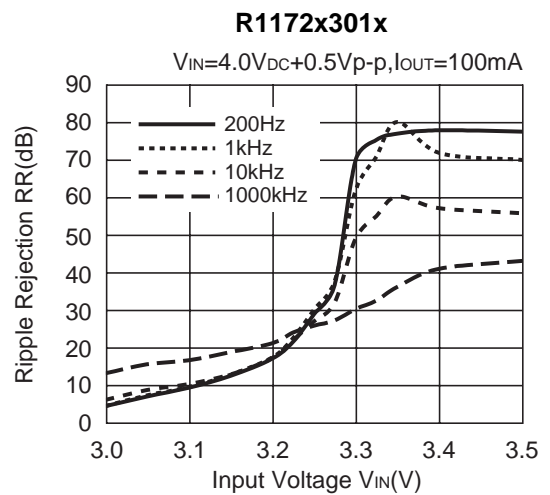
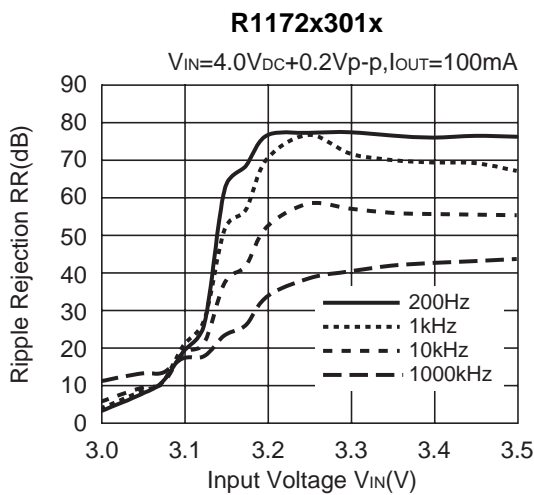
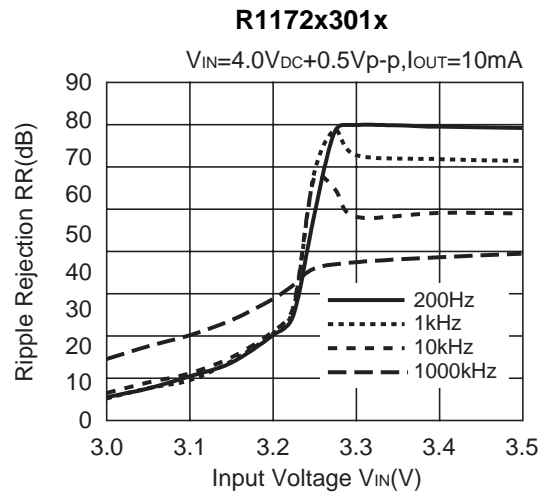
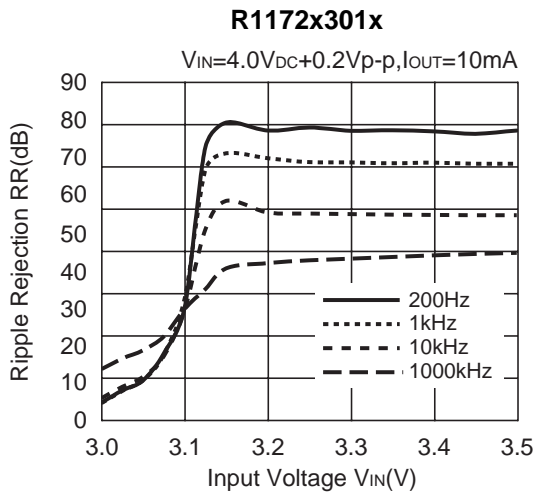

10) Ripple Rejection vs. Frequency

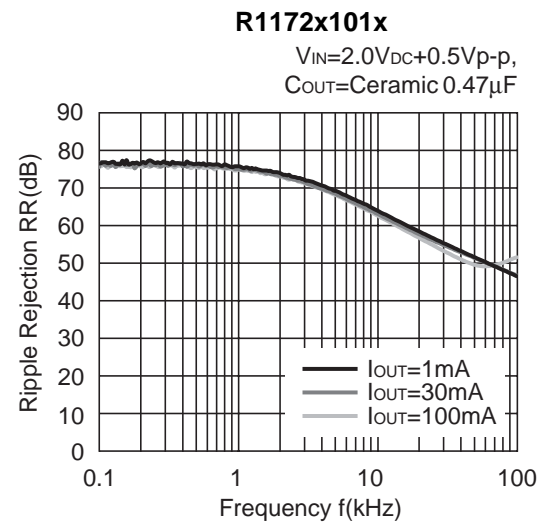
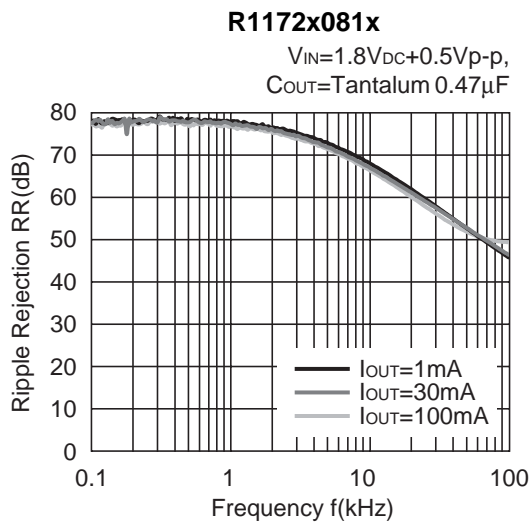

**R1172x301x**

$V_{IN}=4.0V_{DC}+0.5V_{p-p}$ ,  
 $C_{OUT}=\text{Ceramic } 0.47\mu\text{F}$

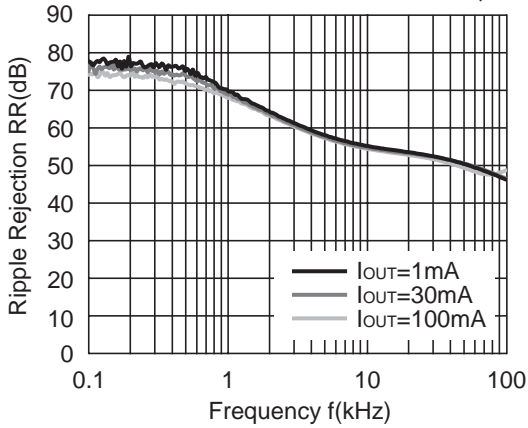

**R1172x401x**

$V_{IN}=5.0V_{DC}+0.5V_{p-p}$ ,  
 $C_{OUT}=\text{Ceramic } 0.47\mu\text{F}$

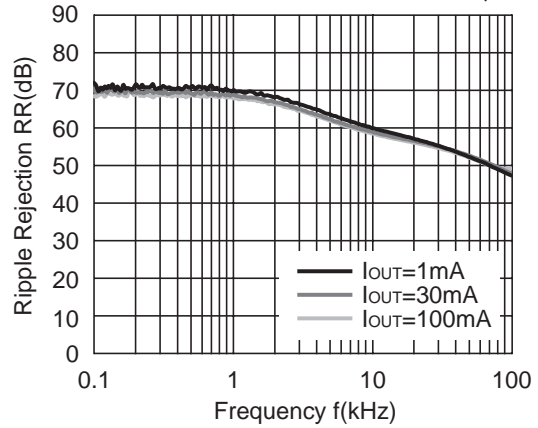

**R1172x451x**

$V_{IN}=5.5V_{DC}+0.5V_{p-p}$ ,  
 $C_{OUT}=\text{Ceramic } 0.47\mu\text{F}$

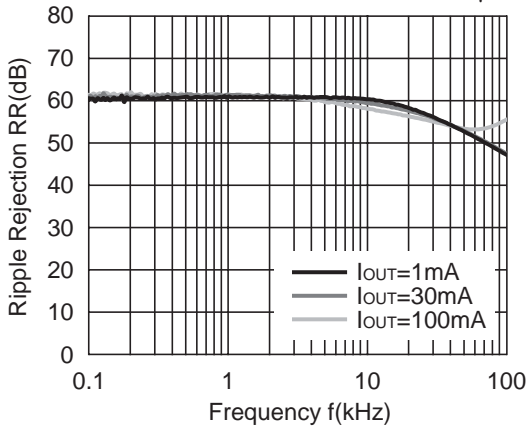

**R1172x501x**

$V_{IN}=6.0V_{DC}+0.5V_{p-p}$ ,  
 $C_{OUT}=\text{Ceramic } 0.47\mu\text{F}$

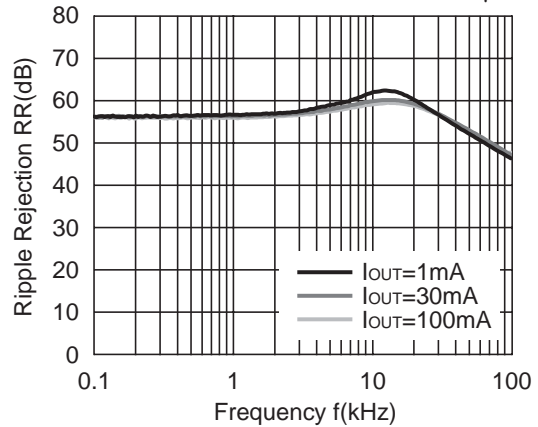

**11) Line Transient Response ( $t_r=t_f=5\mu\text{s}$ ,  $I_{OUT}=100\text{mA}$ )**

**R1172x081x**

$C_{OUT}=\text{Tantalum } 4.7\mu\text{F}$

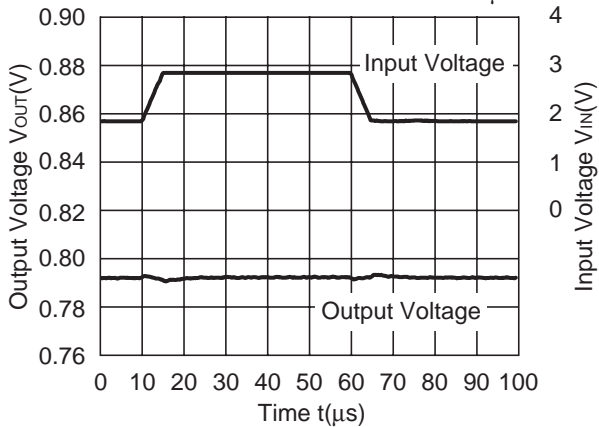

**R1172x101x**

$C_{OUT}=\text{Ceramic } 4.7\mu\text{F}$

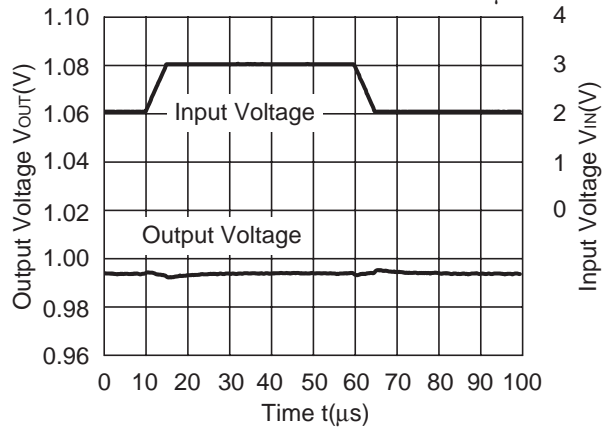



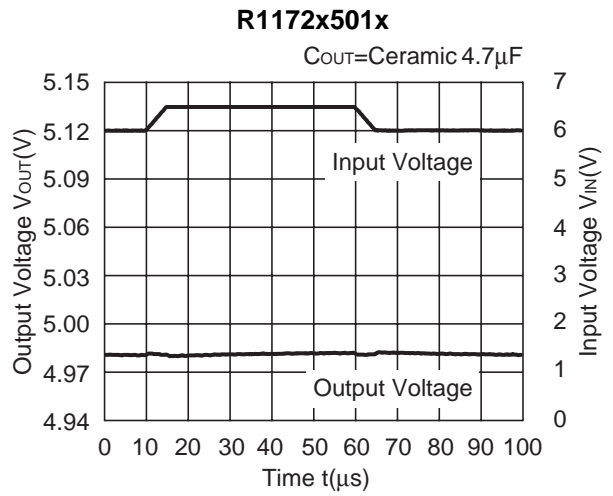
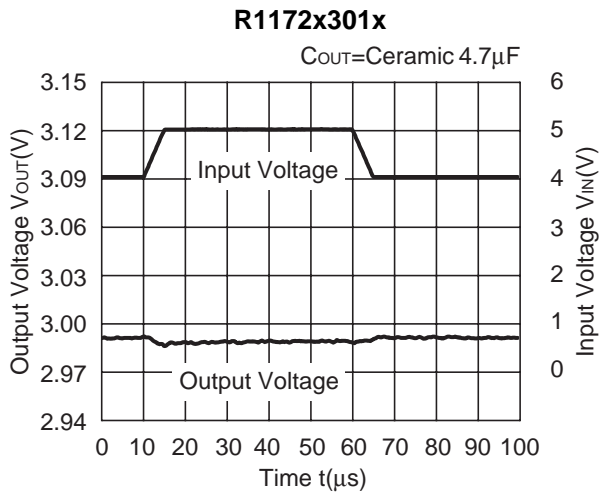

**12) Load Transient Response (tr=tf=500ns)**

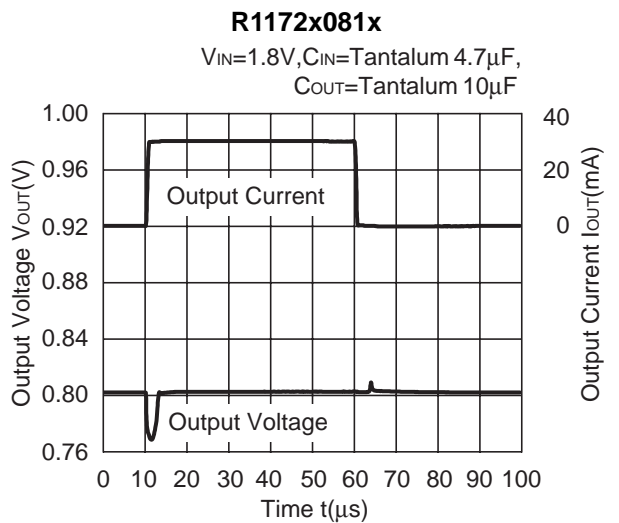
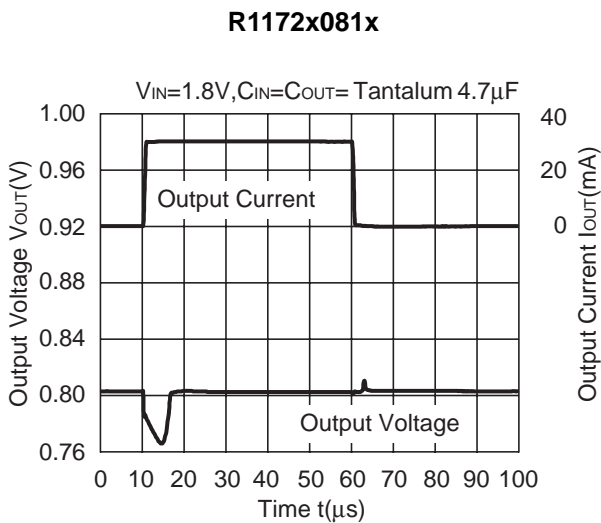
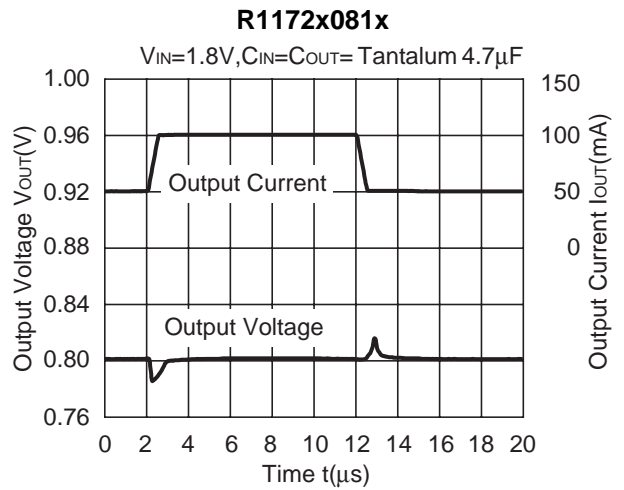
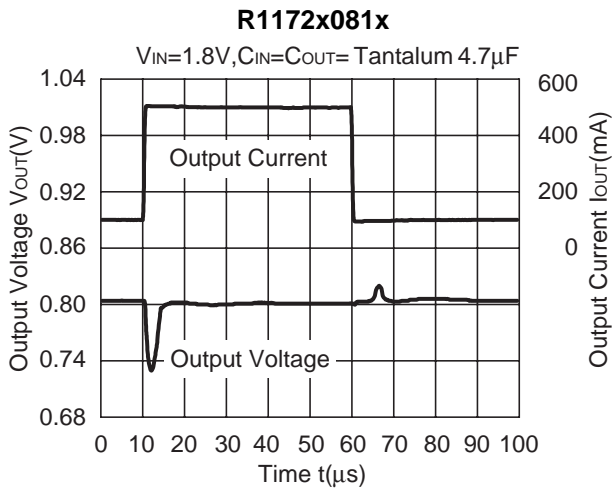

R1172x101x

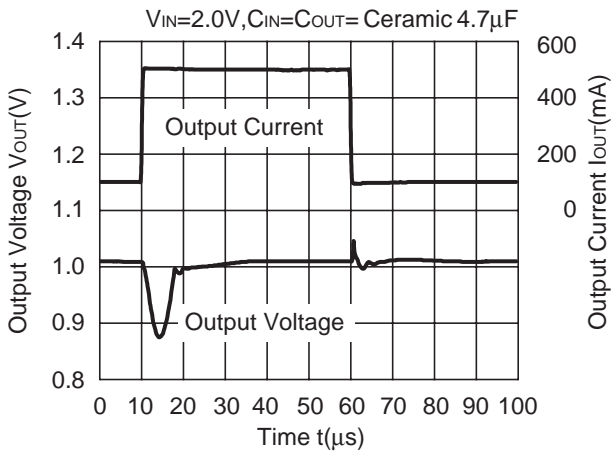

R1172x101x

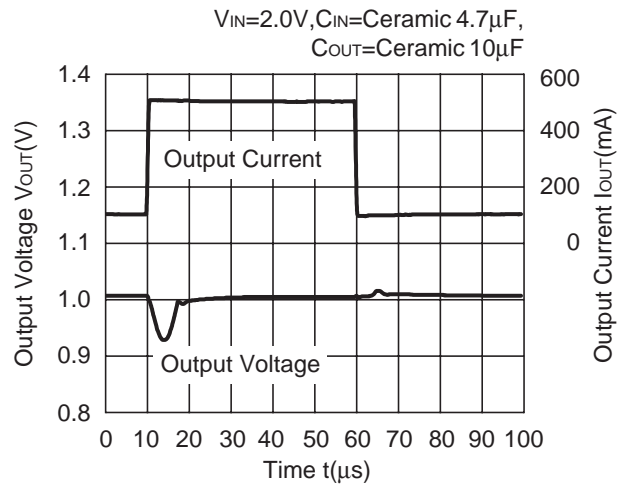

R1172x101x

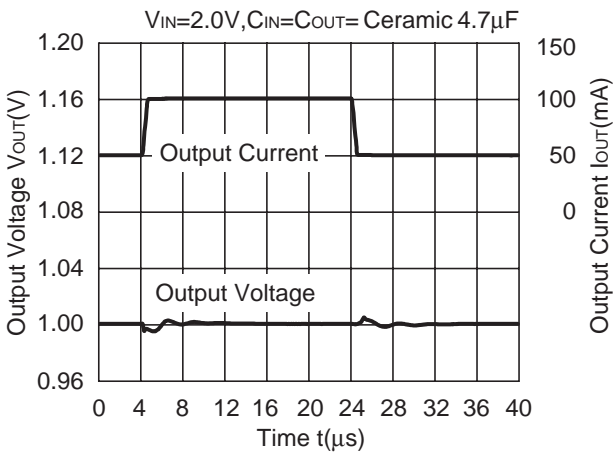

R1172x101x

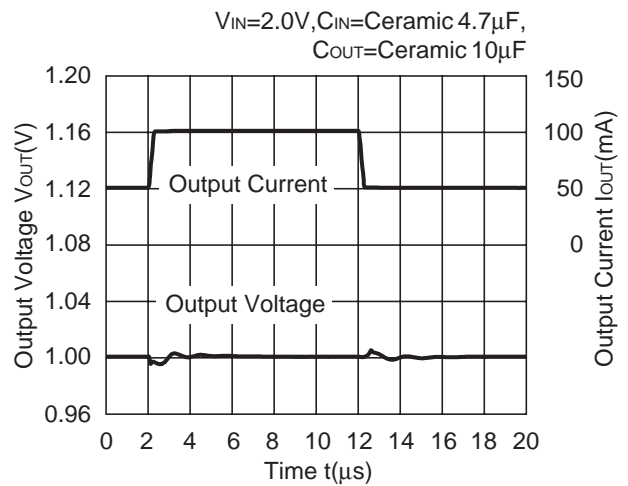

R1172x101x

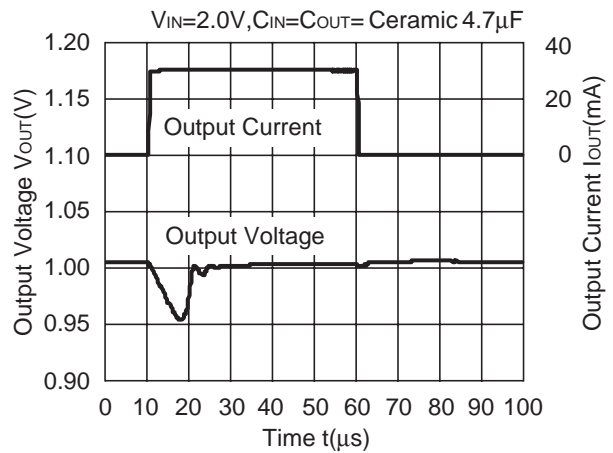

R1172x101x

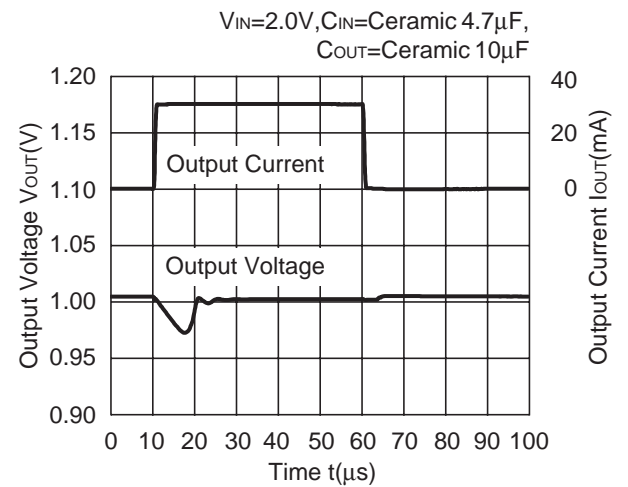

**R1172x301x**

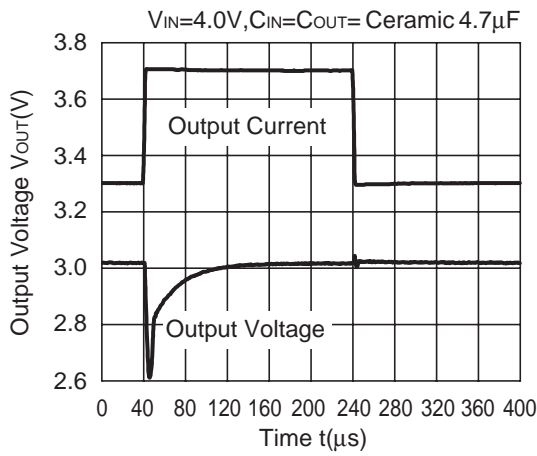

**R1172x301x**

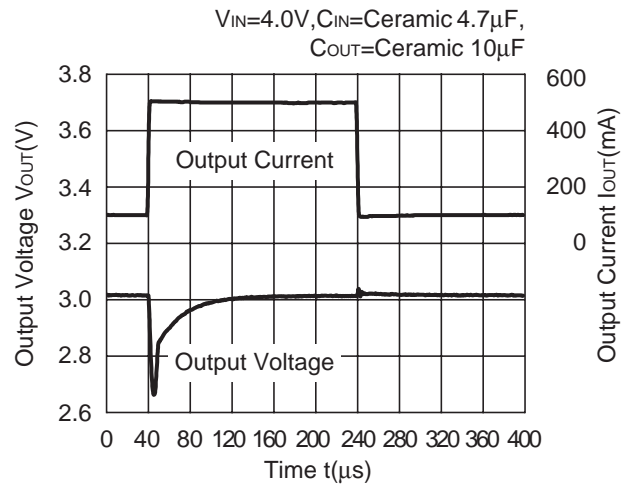

**R1172x301x**

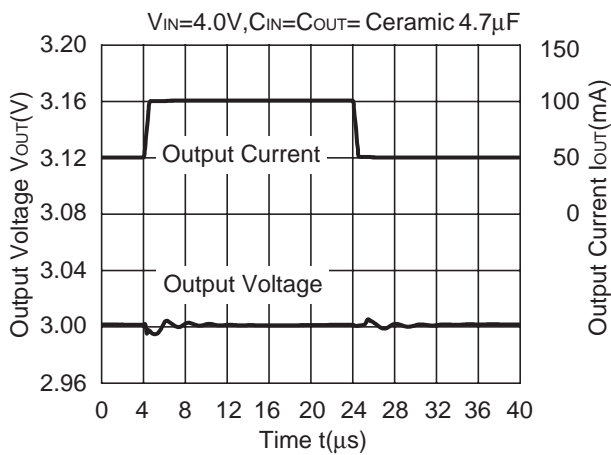

**R1172x301x**

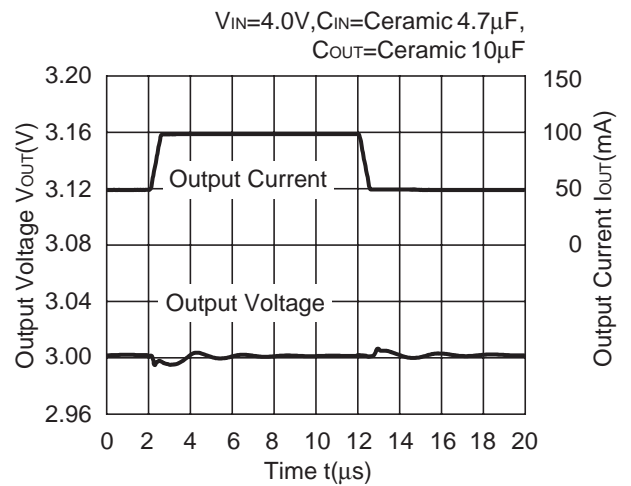

**R1172x301x**

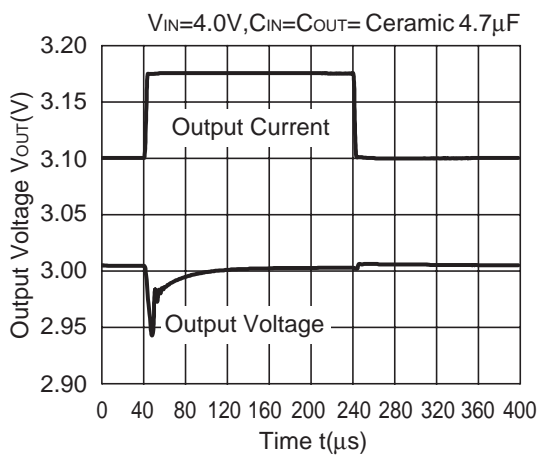

**R1172x301x**

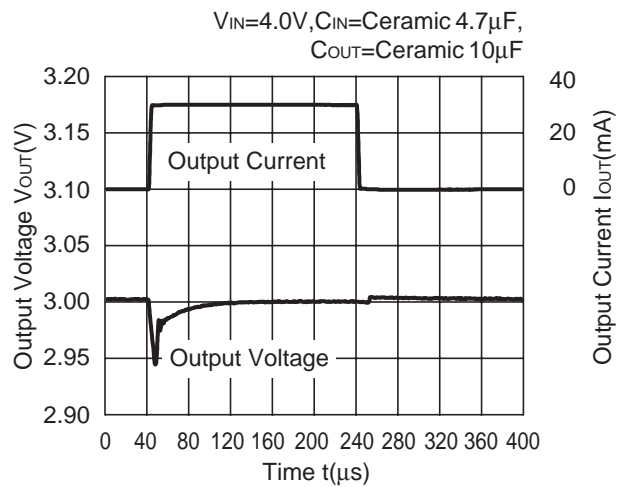

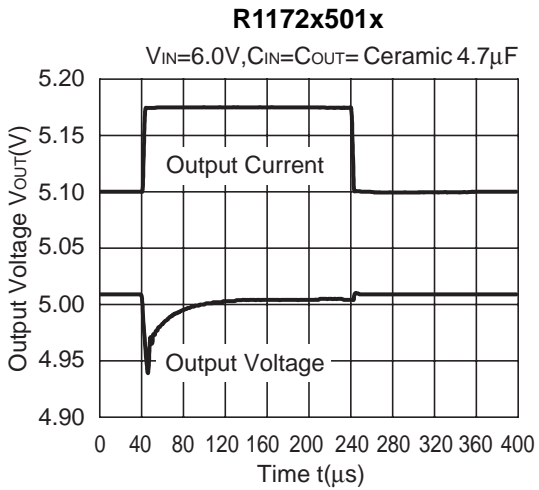
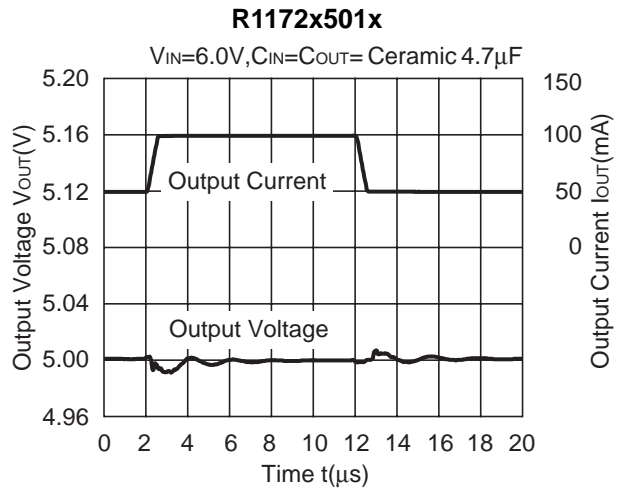
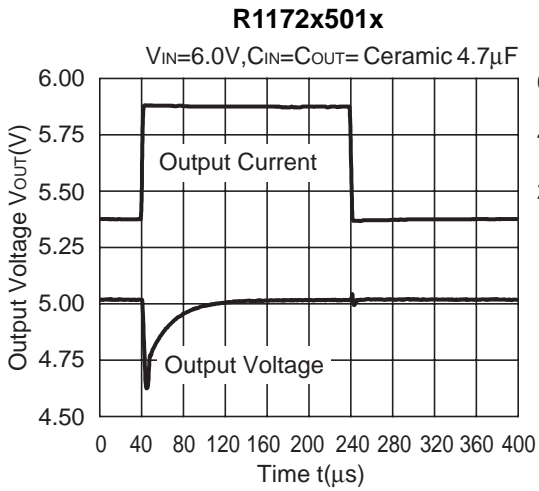

**13) Turn-on speed with CE pin control**

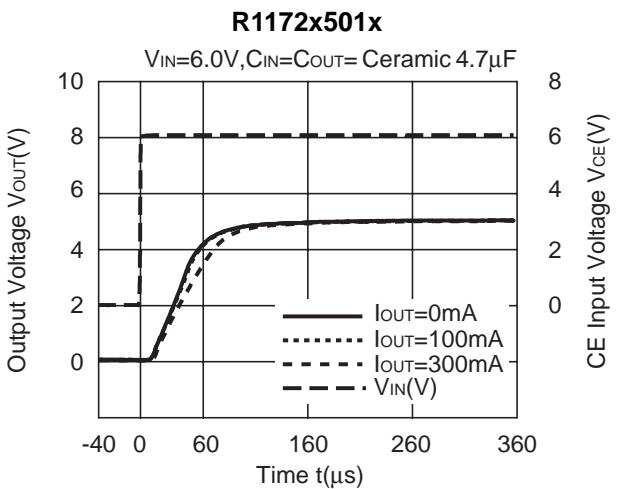
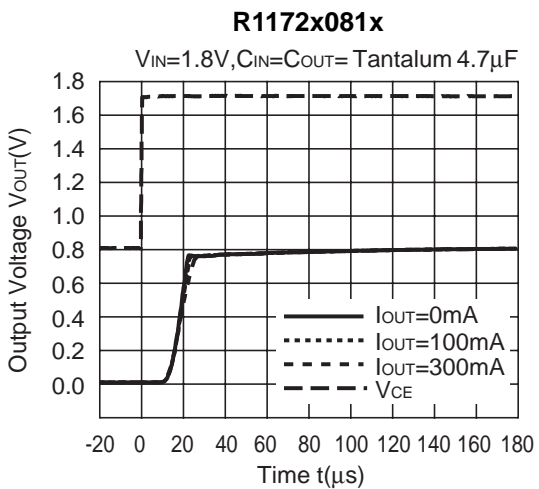

14) Turn-off speed with CE pin control

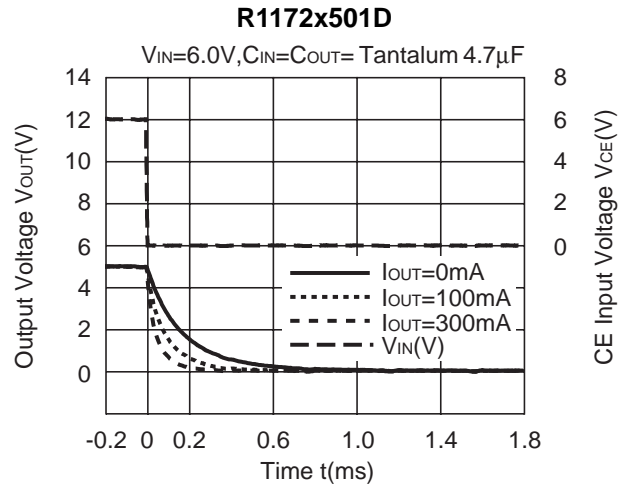
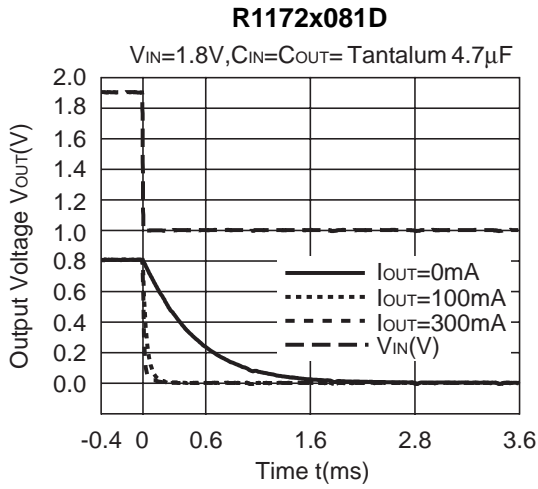

15) Inrush Current ( $I_{out}=100mA, C_{in}=\text{none}$ )

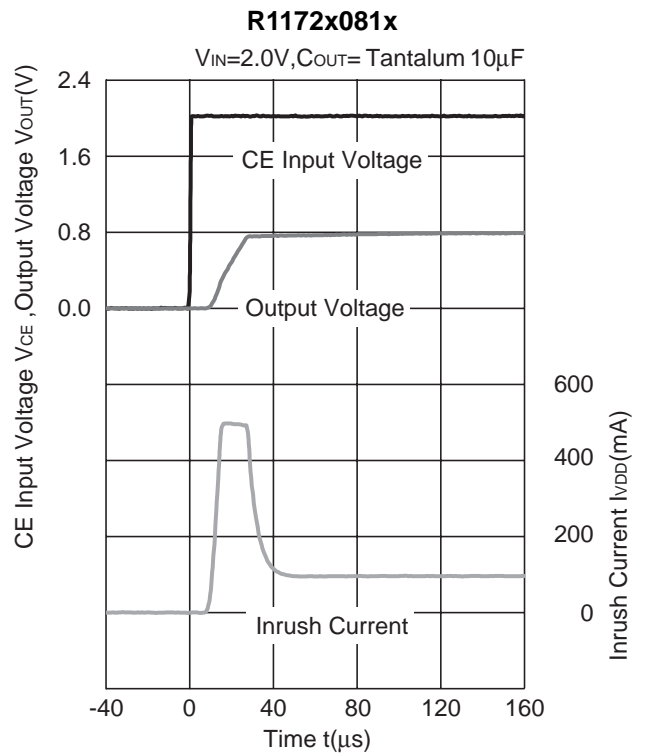
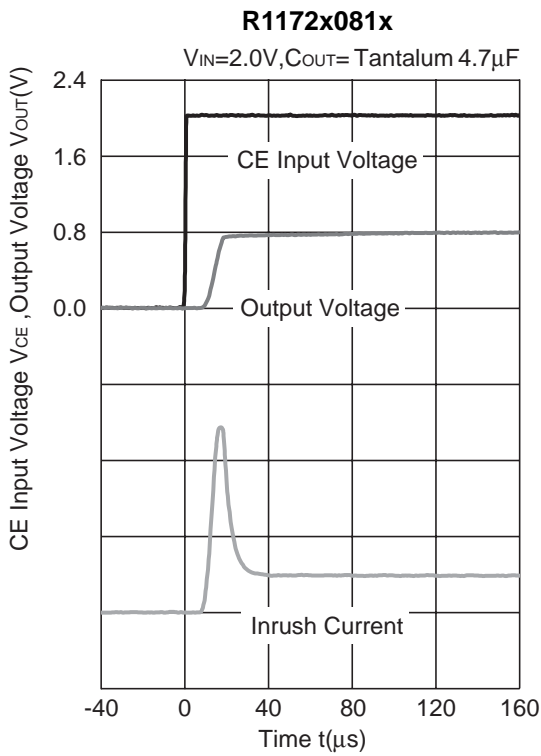

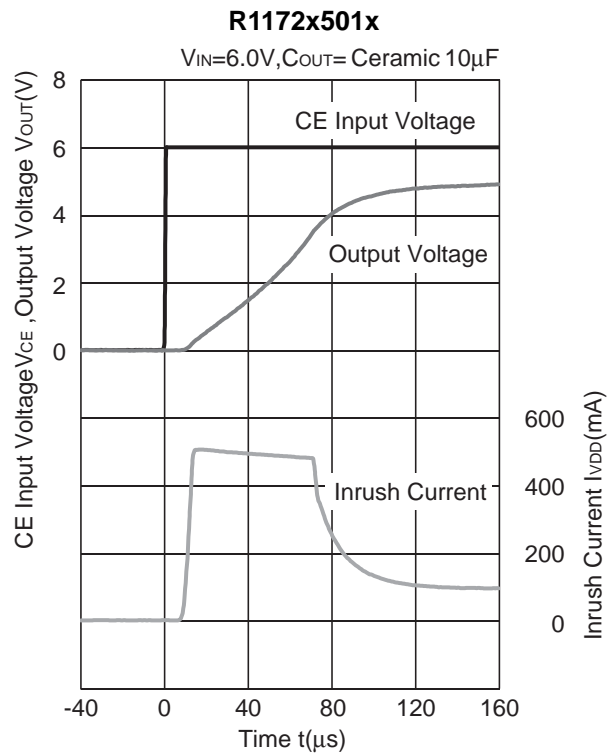
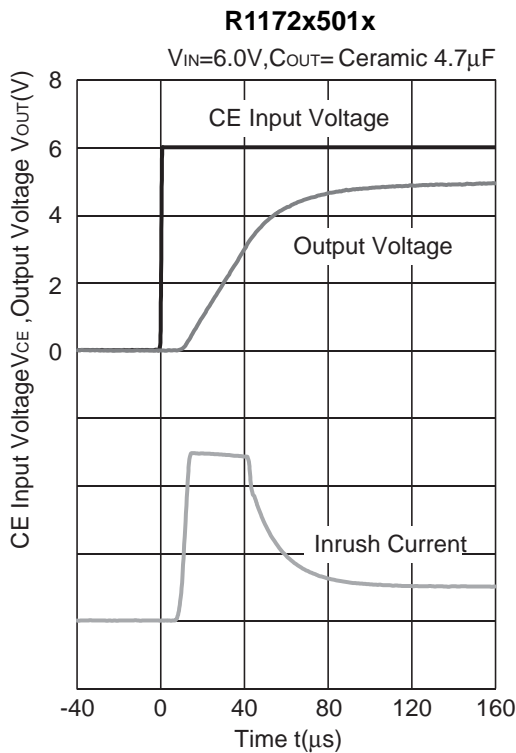
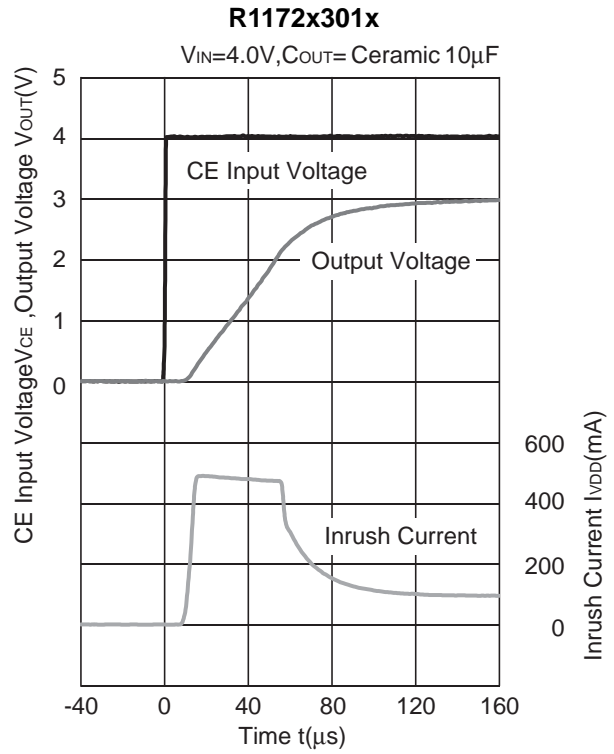
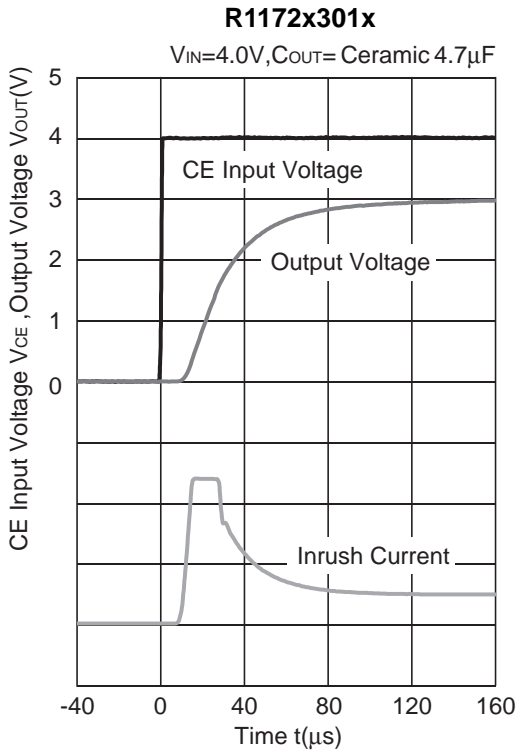

## ESR vs. Output Current

When using these ICs, consider the following points:

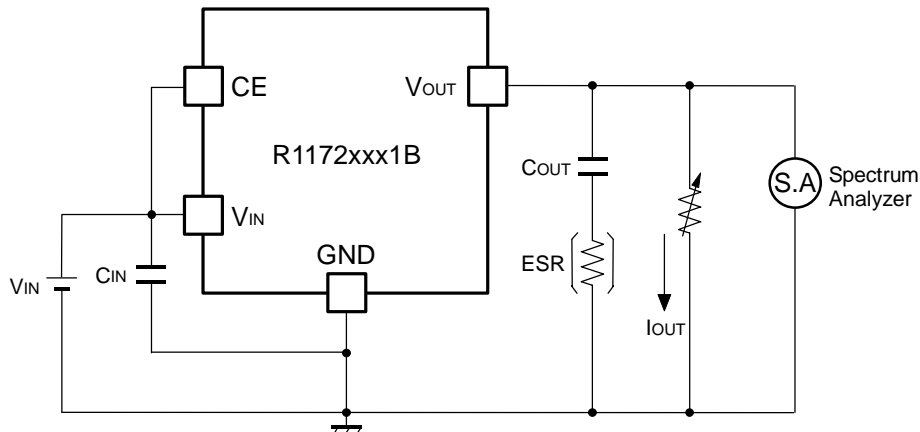

0.8V to 3.3V Output type:  $C_{OUT}=4.7\mu\text{F}$  (Kyocera CM105X5R475M06AB)  
 5.0V Output type :  $C_{OUT}=4.7\mu\text{F}$  (Kyocera CT21X5R475K06AB)

As an output capacitor for this IC, Ceramic capacitor is recommendable. However, other low ESR type capacitor can be used with this IC.

For your reference, noise level is tested, and if the noise level is  $40\mu\text{V}$  or less than  $40\mu\text{V}$ , the ESR values are plotted as stable area. Upper limit is described in the next five graphs, or ESR vs. Output Current. (Hatched area is the stable area.)

### Measurement conditions

- $V_{IN}=V_{OUT}+1\text{V}$
- Frequency Band: 10Hz to 1MHz
- Temperature :  $25^\circ\text{C}$

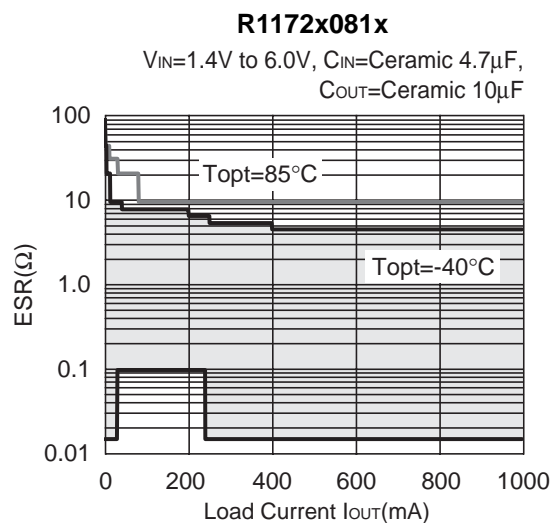
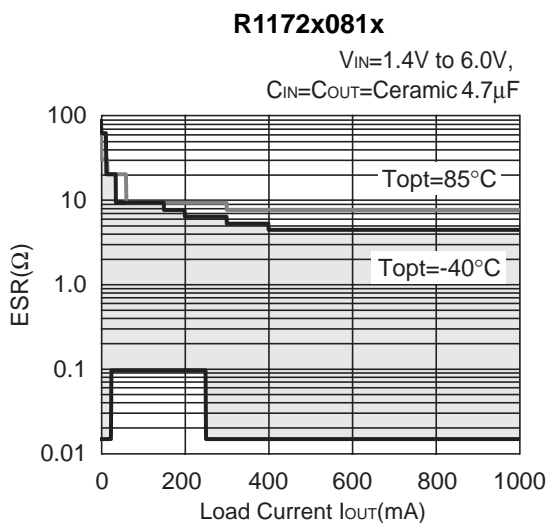

**R1172x101x**

$V_{IN}=1.4V$  to  $6.0V$ ,  
 $C_{IN}=C_{OUT}=\text{Ceramic } 4.7\mu F$

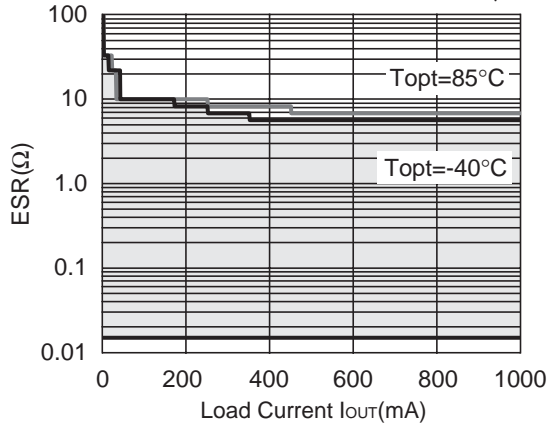

**R1172x301x**

$V_{IN}=3.1V$  to  $6.0V$ ,  
 $C_{IN}=C_{OUT}=\text{Ceramic } 4.7\mu F$

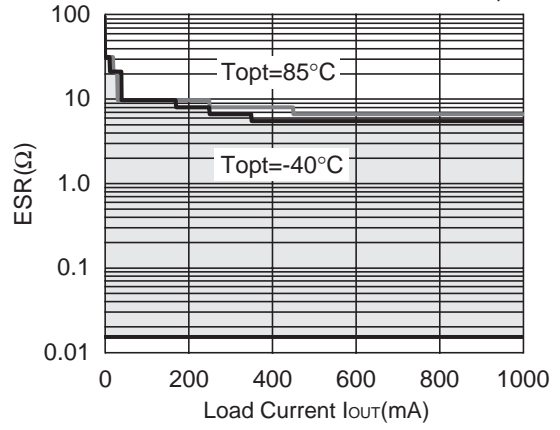

**R1172x501x**

$V_{IN}=5.3V$  to  $6.0V$ ,  
 $C_{IN}=C_{OUT}=\text{Ceramic } 4.7\mu F$

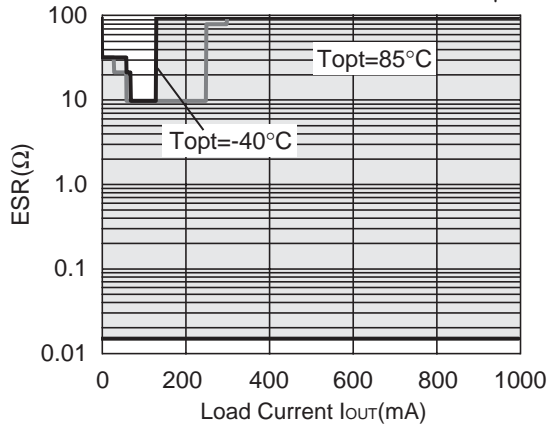





### POWER DISSIPATION (SOT-23-5)

This specification is at mounted on board. Power Dissipation ( $P_D$ ) depends on conditions of mounting on board. This specification is based on the measurement at the condition below:

(Power Dissipation (SOT-23-5) is substitution of SOT-23-6.)

Measurement Conditions

	Standard Land Pattern
Environment	Mounting on Board (Wind velocity=0m/s)
Board Material	Glass cloth epoxy plactic (Double sided)
Board Dimensions	40mm × 40mm × 1.6mm
Copper Ratio	Top side : Approx. 50% , Back side : Approx. 50%
Through-hole	φ0.5mm × 44pcs

Measurement Result

( $T_{opt}=25^{\circ}C, T_{jmax}=125^{\circ}C$ )

	Standard Land Pattern	Free Air
Power Dissipation	420mW	250mW
Thermal Resistance	$\theta_{ja}=(125-25^{\circ}C)/0.42W=263^{\circ}C/W$	400 $^{\circ}C/W$

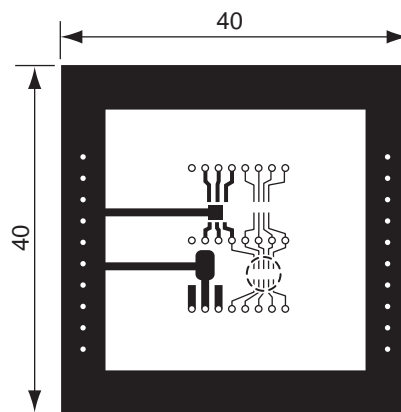
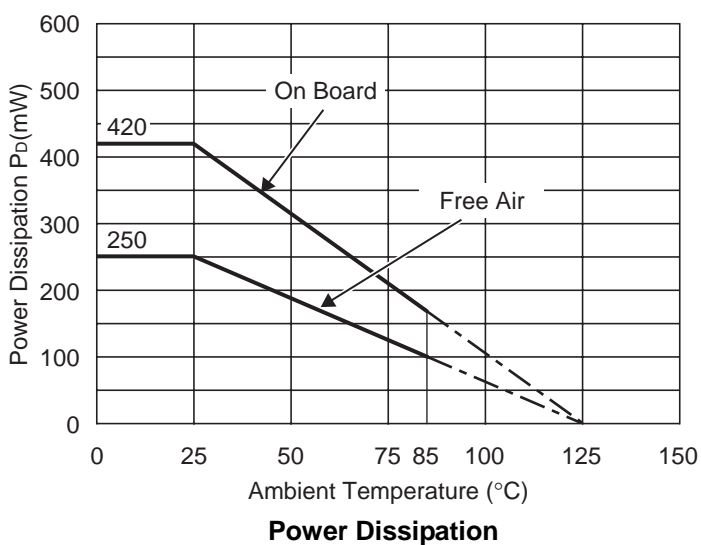

Measurement Board Pattern

○ IC Mount Area Unit : mm

### RECOMMENDED LAND PATTERN

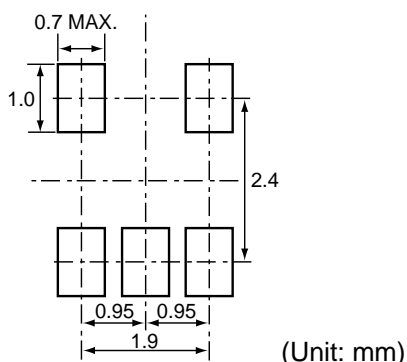

• SOT-89-5

Unit: mm

PACKAGE DIMENSIONS

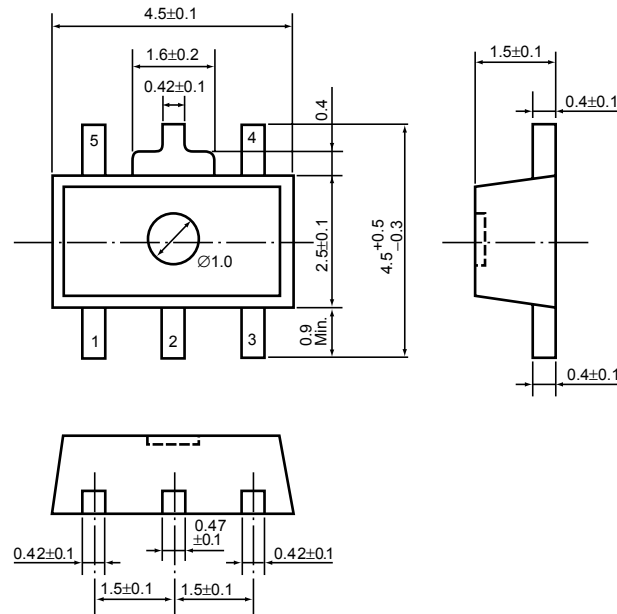

TAPING SPECIFICATION (T1: Standard Type)

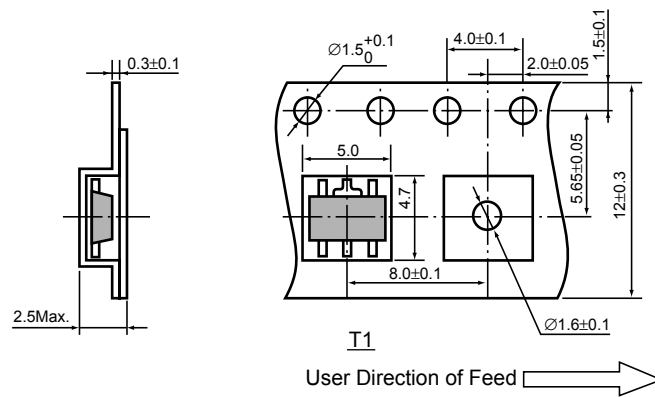

TAPING REEL DIMENSIONS REUSE REEL (EIAJ-RRM-12Bc)

(1reel=1000pcs)

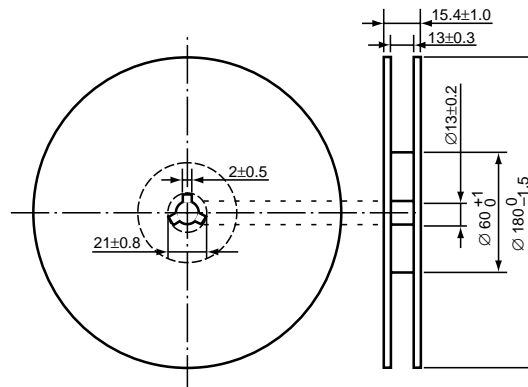

## POWER DISSIPATION (SOT-89-5)

This specification is at mounted on board. Power Dissipation ( $P_D$ ) depends on conditions of mounting on board. This specification is based on the measurement at the condition below:

### Measurement Conditions

	High Wattage Land Pattern	Standard Land Pattern
Environment	Mounting on Board (Wind velocity=0m/s)	Mounting on Board (Wind velocity=0m/s)
Board Material	Glass cloth epoxy plastic (Double sided)	Glass cloth epoxy plastic (Double sided)
Board Dimensions	30mm × 30mm × 1.6mm	50mm × 50mm × 1.6mm
Copper Ratio	Top side : Approx. 20% , Back side : Approx. 100%	Top side : Approx. 10% , Back side : Approx. 100%
Through-hole	φ0.85mm × 10pcs	-

### Measurement Result

( $T_{opt}=25^{\circ}\text{C}$ ,  $T_{jmax}=125^{\circ}\text{C}$ )

	High Wattage Land Pattern	Standard Land Pattern	Free Air
Power Dissipation	1300mW	900mW	500mW
Thermal Resistance	77°C/W	111°C/W	200°C/W

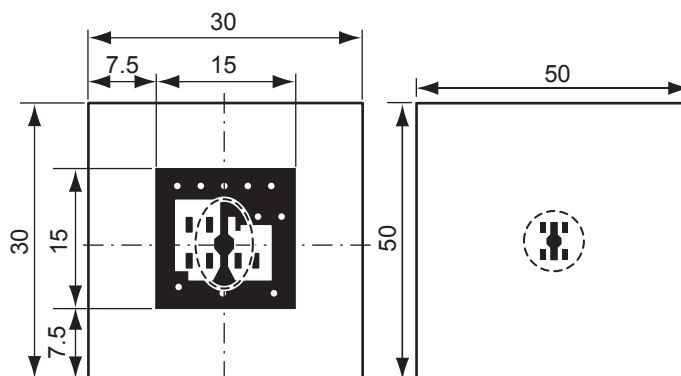
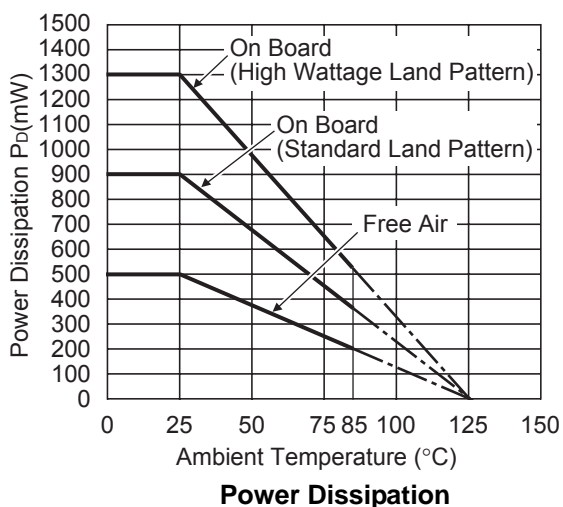

High Wattage

Standard

Measurement Board Pattern

○ IC Mount Area (Unit : mm)

## RECOMMENDED LAND PATTERN (SOT-89-5)

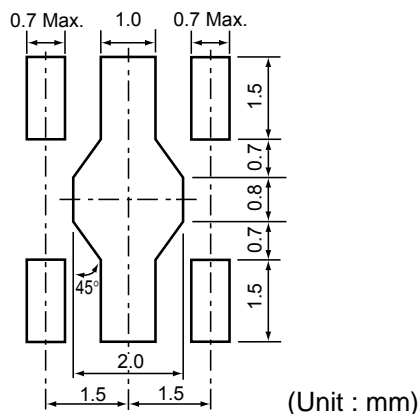

• HSON-6

Unit: mm

PACKAGE DIMENSIONS

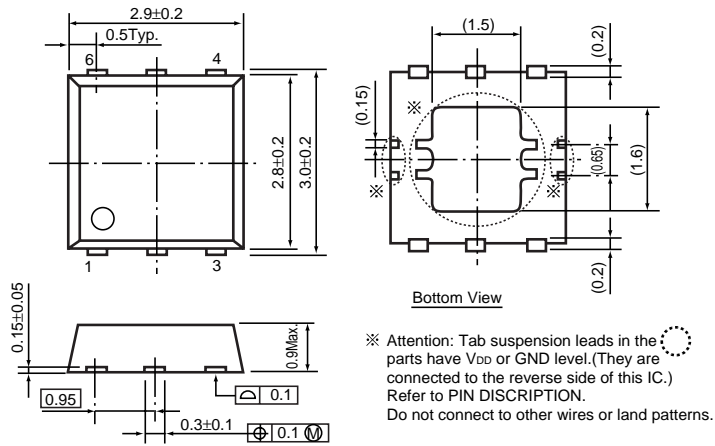

TAPING SPECIFICATION

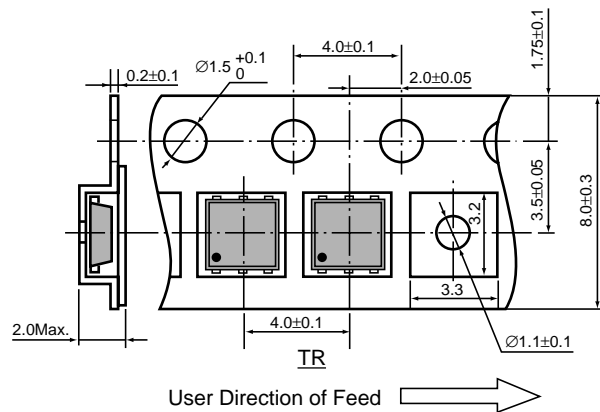

TAPING REEL DIMENSIONS REUSE REEL (EIAJ-RRM-08Bc)

(1reel=3000pcs)

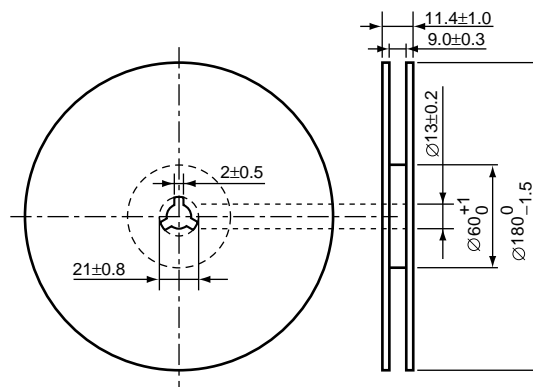

## POWER DISSIPATION (HSON-6)

This specification is at mounted on board. Power Dissipation ( $P_D$ ) depends on conditions of mounting on board. This specification is based on the measurement at the condition below:

### Measurement Conditions

	Standard Land Pattern
Environment	Mounting on Board (Wind velocity=0m/s)
Board Material	Glass cloth epoxy plactic (Double sided)
Board Dimensions	40mm × 40mm × 1.6mm
Copper Ratio	Top side : Approx. 50% , Back side : Approx. 50%
Through-hole	φ0.5mm × 44pcs

### Measurement Result

( $T_{opt}=25^{\circ}\text{C}$ ,  $T_{jmax}=125^{\circ}\text{C}$ )

	Standard Land Pattern	Free Air
Power Dissipation	900mW	400mW
Thermal Resistance	$\theta_{ja}=(125-25^{\circ}\text{C})/0.9\text{W}=111^{\circ}\text{C/W}$	250°C/W

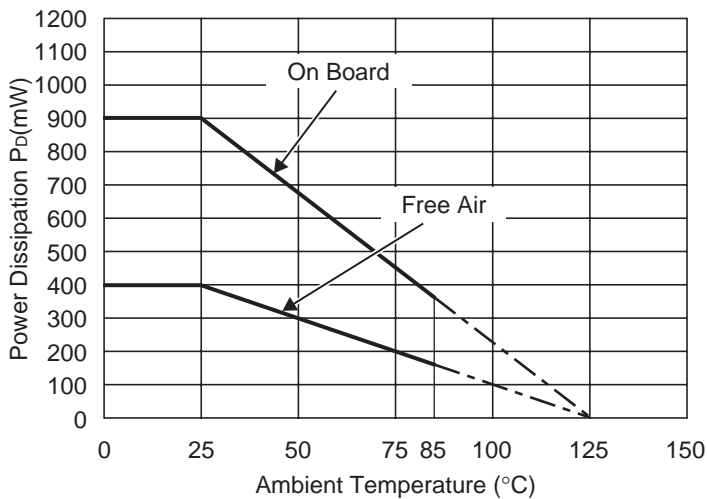

Power Dissipation

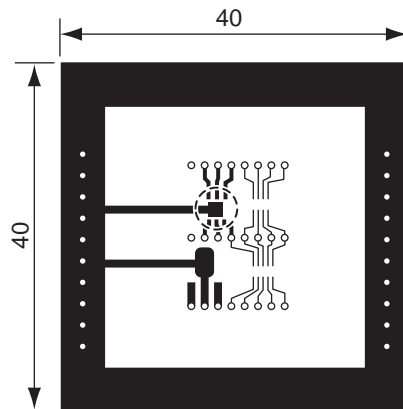

Measurement Board Pattern

○ IC Mount Area Unit : mm

## RECOMMENDED LAND PATTERN

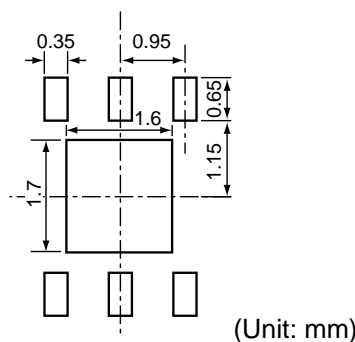

• HSOP-6J

Unit: mm

PACKAGE DIMENSIONS

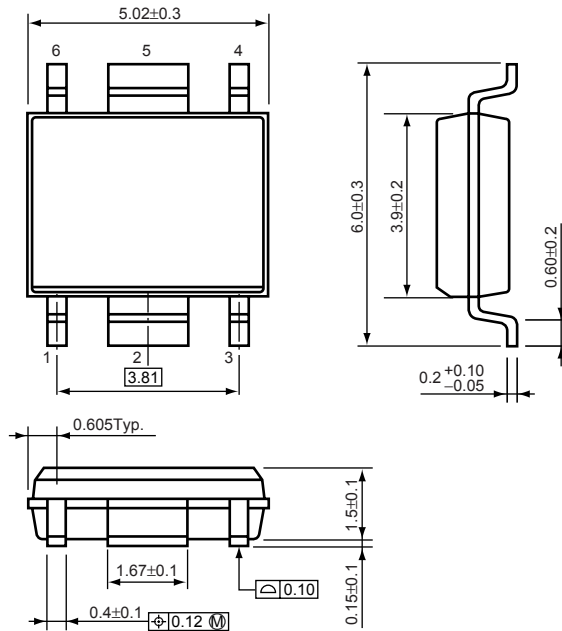

TAPING SPECIFICATION

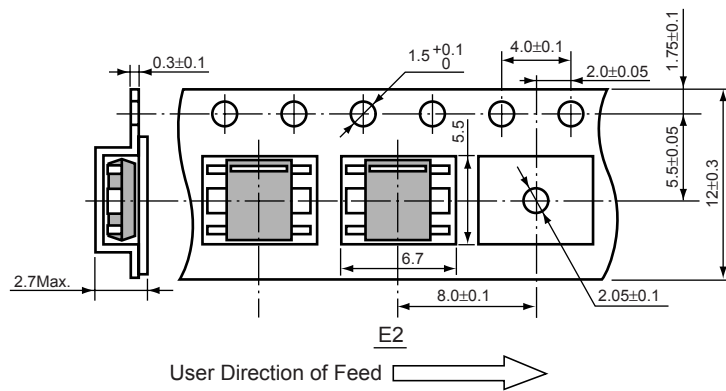

TAPING REEL DIMENSIONS REUSE REEL (EIAJ-RRM-12Bc)

(1reel=1000pcs)

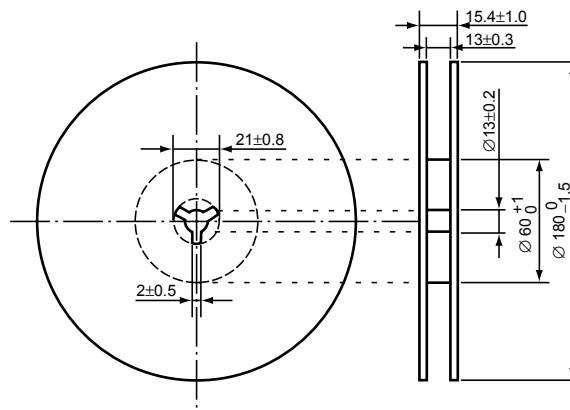

### POWER DISSIPATION (HSOP-6J)

This specification is at mounted on board. Power Dissipation ( $P_D$ ) depends on conditions of mounting on board. This specification is based on the measurement at the condition below:

Measurement Conditions

	High Wattage Land Pattern	Standard Land Pattern
Environment	Mounting on Board (Wind velocity=0m/s)	Mounting on Board (Wind velocity=0m/s)
Board Material	Glass cloth epoxy plactic (Double sided)	Glass cloth epoxy plactic (Double sided)
Board Dimensions	50mm × 50mm × 1.6mm	50mm × 50mm × 1.6mm
Copper Ratio	90%	50%
Through-hole	φ0.5mm × 44pcs	φ0.5mm × 44pcs

Measurement Result

( $T_{opt}=25^{\circ}C, T_{jmax}=125^{\circ}C$ )

	High Wattage Land Pattern	Standard Land Pattern	Free Air
Power Dissipation	2000mW	1700mW	540mW
Thermal Resistance	50°C/W	59°C/W	185°C/W

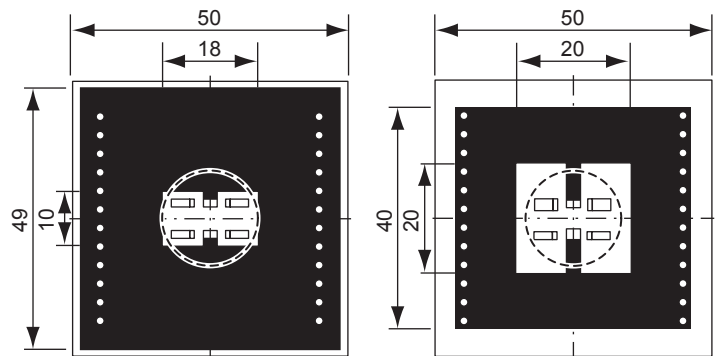
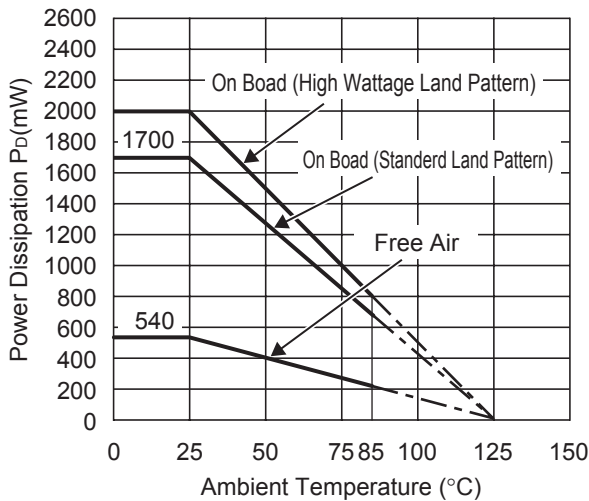

High Wattage Standard

Measurement Board Pattern

○ IC Mount Area Unit : mm

### RECOMMENDED LAND PATTERN (HSOP-6J)

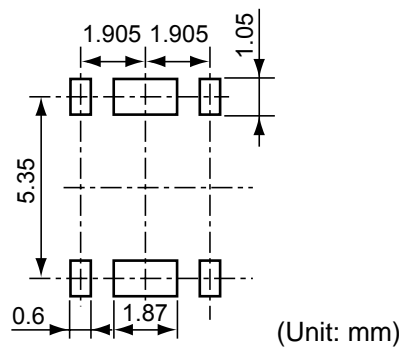

(Unit: mm)





R1172H SERIES MARK SPECIFICATION

• SOT-89-5

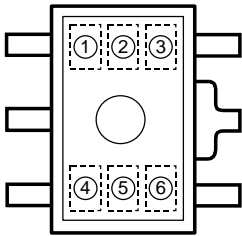

- ① : J (fixed)
  - ②, ③ : Setting Voltage
  - ④ : Type (A,B,D)
  - ⑤, ⑥ : Lot Number
- (refer to Part Number vs. Product Code)

• Part Number vs. Product Code

Part Number	Product Code			
	①	②	③	④
R1172H081A	J	0	8	A
R1172H091A	J	0	9	A
R1172H101A	J	1	0	A
R1172H111A	J	1	1	A
R1172H121A	J	1	2	A
R1172H131A	J	1	3	A
R1172H141A	J	1	4	A
R1172H151A	J	1	5	A
R1172H161A	J	1	6	A
R1172H171A	J	1	7	A
R1172H181A	J	1	8	A
R1172H191A	J	1	9	A
R1172H201A	J	2	0	A
R1172H211A	J	2	1	A
R1172H221A	J	2	2	A
R1172H231A	J	2	3	A
R1172H241A	J	2	4	A
R1172H251A	J	2	5	A
R1172H261A	J	2	6	A
R1172H271A	J	2	7	A
R1172H281A	J	2	8	A
R1172H291A	J	2	9	A
R1172H301A	J	3	0	A
R1172H311A	J	3	1	A
R1172H321A	J	3	2	A
R1172H331A	J	3	3	A
R1172H341A	J	3	4	A
R1172H351A	J	3	5	A
R1172H361A	J	3	6	A
R1172H371A	J	3	7	A
R1172H381A	J	3	8	A
R1172H391A	J	3	9	A
R1172H401A	J	4	0	A
R1172H411A	J	4	1	A
R1172H421A	J	4	2	A
R1172H431A	J	4	3	A

Part Number	Product Code			
	①	②	③	④
R1172H441A	J	4	4	A
R1172H451A	J	4	5	A
R1172H461A	J	4	6	A
R1172H471A	J	4	7	A
R1172H481A	J	4	8	A
R1172H491A	J	4	9	A
R1172H501A	J	5	0	A
R1172H181A5	J	0	1	A
R1172H281A5	J	0	2	A
R1172H081B	J	0	8	B
R1172H091B	J	0	9	B
R1172H101B	J	1	0	B
R1172H111B	J	1	1	B
R1172H121B	J	1	2	B
R1172H131B	J	1	3	B
R1172H141B	J	1	4	B
R1172H151B	J	1	5	B
R1172H161B	J	1	6	B
R1172H171B	J	1	7	B
R1172H181B	J	1	8	B
R1172H191B	J	1	9	B
R1172H201B	J	2	0	B
R1172H211B	J	2	1	B
R1172H221B	J	2	2	B
R1172H231B	J	2	3	B
R1172H241B	J	2	4	B
R1172H251B	J	2	5	B
R1172H261B	J	2	6	B
R1172H271B	J	2	7	B
R1172H281B	J	2	8	B
R1172H291B	J	2	9	B
R1172H301B	J	3	0	B
R1172H311B	J	3	1	B
R1172H321B	J	3	2	B
R1172H331B	J	3	3	B

Part Number	Product Code			
	①	②	③	④
R1172H341B	J	3	4	B
R1172H351B	J	3	5	B
R1172H361B	J	3	6	B
R1172H371B	J	3	7	B
R1172H381B	J	3	8	B
R1172H391B	J	3	9	B
R1172H401B	J	4	0	B
R1172H411B	J	4	1	B
R1172H421B	J	4	2	B
R1172H431B	J	4	3	B
R1172H441B	J	4	4	B
R1172H451B	J	4	5	B
R1172H461B	J	4	6	B
R1172H471B	J	4	7	B
R1172H481B	J	4	8	B
R1172H491B	J	4	9	B
R1172H501B	J	5	0	B
R1172H181B5	J	0	1	B
R1172H281B5	J	0	2	B
R1172H081D	J	0	8	D
R1172H091D	J	0	9	D
R1172H101D	J	1	0	D
R1172H111D	J	1	1	D
R1172H121D	J	1	2	D
R1172H131D	J	1	3	D
R1172H141D	J	1	4	D
R1172H151D	J	1	5	D
R1172H161D	J	1	6	D
R1172H171D	J	1	7	D
R1172H181D	J	1	8	D
R1172H191D	J	1	9	D
R1172H201D	J	2	0	D
R1172H211D	J	2	1	D
R1172H221D	J	2	2	D
R1172H231D	J	2	3	D

Part Number	Product Code			
	①	②	③	④
R1172H241D	J	2	4	D
R1172H251D	J	2	5	D
R1172H261D	J	2	6	D
R1172H271D	J	2	7	D
R1172H281D	J	2	8	D
R1172H291D	J	2	9	D
R1172H301D	J	3	0	D
R1172H311D	J	3	1	D
R1172H321D	J	3	2	D
R1172H331D	J	3	3	D
R1172H341D	J	3	4	D
R1172H351D	J	3	5	D
R1172H361D	J	3	6	D
R1172H371D	J	3	7	D
R1172H381D	J	3	8	D
R1172H391D	J	3	9	D
R1172H401D	J	4	0	D
R1172H411D	J	4	1	D
R1172H421D	J	4	2	D
R1172H431D	J	4	3	D
R1172H441D	J	4	4	D
R1172H451D	J	4	5	D
R1172H461D	J	4	6	D
R1172H471D	J	4	7	D
R1172H481D	J	4	8	D
R1172H491D	J	4	9	D
R1172H501D	J	5	0	D
R1172H181D5	J	0	1	D
R1172H281D5	J	0	2	D

## R1172D SERIES MARK SPECIFICATION

## ● HSON-6

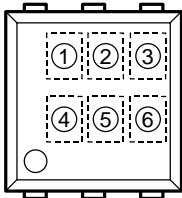

① : G (fixed)

②, ③ : Setting Voltage

④ : Type (A, B, D)

⑤, ⑥ : Lot Number

(refer to Part Number vs. Product Code)

## ● Part Number vs. Product Code

Part Number	Product Code			
	①	②	③	④
R1172D081A	G	0	8	A
R1172D091A	G	0	9	A
R1172D101A	G	1	0	A
R1172D111A	G	1	1	A
R1172D121A	G	1	2	A
R1172D131A	G	1	3	A
R1172D141A	G	1	4	A
R1172D151A	G	1	5	A
R1172D161A	G	1	6	A
R1172D171A	G	1	7	A
R1172D181A	G	1	8	A
R1172D191A	G	1	9	A
R1172D201A	G	2	0	A
R1172D211A	G	2	1	A
R1172D221A	G	2	2	A
R1172D231A	G	2	3	A
R1172D241A	G	2	4	A
R1172D251A	G	2	5	A
R1172D261A	G	2	6	A
R1172D271A	G	2	7	A
R1172D281A	G	2	8	A
R1172D291A	G	2	9	A
R1172D301A	G	3	0	A
R1172D311A	G	3	1	A
R1172D321A	G	3	2	A
R1172D331A	G	3	3	A
R1172D341A	G	3	4	A
R1172D351A	G	3	5	A
R1172D361A	G	3	6	A
R1172D371A	G	3	7	A
R1172D381A	G	3	8	A
R1172D391A	G	3	9	A
R1172D401A	G	4	0	A
R1172D411A	G	4	1	A
R1172D421A	G	4	2	A
R1172D431A	G	4	3	A

Part Number	Product Code			
	①	②	③	④
R1172D441A	G	4	4	A
R1172D451A	G	4	5	A
R1172D461A	G	4	6	A
R1172D471A	G	4	7	A
R1172D481A	G	4	8	A
R1172D491A	G	4	9	A
R1172D501A	G	5	0	A
R1172D181A5	G	0	1	A
R1172D281A5	G	0	2	A
R1172D081B	G	0	8	B
R1172D091B	G	0	9	B
R1172D101B	G	1	0	B
R1172D111B	G	1	1	B
R1172D121B	G	1	2	B
R1172D131B	G	1	3	B
R1172D141B	G	1	4	B
R1172D151B	G	1	5	B
R1172D161B	G	1	6	B
R1172D171B	G	1	7	B
R1172D181B	G	1	8	B
R1172D191B	G	1	9	B
R1172D201B	G	2	0	B
R1172D211B	G	2	1	B
R1172D221B	G	2	2	B
R1172D231B	G	2	3	B
R1172D241B	G	2	4	B
R1172D251B	G	2	5	B
R1172D261B	G	2	6	B
R1172D271B	G	2	7	B
R1172D281B	G	2	8	B
R1172D291B	G	2	9	B
R1172D301B	G	3	0	B
R1172D311B	G	3	1	B
R1172D321B	G	3	2	B
R1172D331B	G	3	3	B

Part Number	Product Code			
	①	②	③	④
R1172D341B	G	3	4	B
R1172D351B	G	3	5	B
R1172D361B	G	3	6	B
R1172D371B	G	3	7	B
R1172D381B	G	3	8	B
R1172D391B	G	3	9	B
R1172D401B	G	4	0	B
R1172D411B	G	4	1	B
R1172D421B	G	4	2	B
R1172D431B	G	4	3	B
R1172D441B	G	4	4	B
R1172D451B	G	4	5	B
R1172D461B	G	4	6	B
R1172D471B	G	4	7	B
R1172D481B	G	4	8	B
R1172D491B	G	4	9	B
R1172D501B	G	5	0	B
R1172D181B5	G	0	1	B
R1172D281B5	G	0	2	B
R1172D081D	G	0	8	D
R1172D091D	G	0	9	D
R1172D101D	G	1	0	D
R1172D111D	G	1	1	D
R1172D121D	G	1	2	D
R1172D131D	G	1	3	D
R1172D141D	G	1	4	D
R1172D151D	G	1	5	D
R1172D161D	G	1	6	D
R1172D171D	G	1	7	D
R1172D181D	G	1	8	D
R1172D191D	G	1	9	D
R1172D201D	G	2	0	D
R1172D211D	G	2	1	D
R1172D221D	G	2	2	D
R1172D231D	G	2	3	D

Part Number	Product Code			
	①	②	③	④
R1172D241D	G	2	4	D
R1172D251D	G	2	5	D
R1172D261D	G	2	6	D
R1172D271D	G	2	7	D
R1172D281D	G	2	8	D
R1172D291D	G	2	9	D
R1172D301D	G	3	0	D
R1172D311D	G	3	1	D
R1172D321D	G	3	2	D
R1172D331D	G	3	3	D
R1172D341D	G	3	4	D
R1172D351D	G	3	5	D
R1172D361D	G	3	6	D
R1172D371D	G	3	7	D
R1172D381D	G	3	8	D
R1172D391D	G	3	9	D
R1172D401D	G	4	0	D
R1172D411D	G	4	1	D
R1172D421D	G	4	2	D
R1172D431D	G	4	3	D
R1172D441D	G	4	4	D
R1172D451D	G	4	5	D
R1172D461D	G	4	6	D
R1172D471D	G	4	7	D
R1172D481D	G	4	8	D
R1172D491D	G	4	9	D
R1172D501D	G	5	0	D
R1172D181D5	G	0	1	D
R1172D281D5	G	0	2	D

## R1172S SERIES MARK SPECIFICATION

## ● HSOP-6J

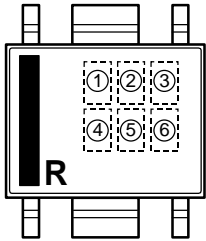

① : B (fixed)

②, ③ : Setting Voltage

④ : Type (A,B,D)

⑤, ⑥ : Lot Number

(refer to Part Number vs. Product Code)

## ● Part Number vs. Product Code

Part Number	Product Code			
	①	②	③	④
R1172S081A	B	0	8	A
R1172S091A	B	0	9	A
R1172S101A	B	1	0	A
R1172S111A	B	1	1	A
R1172S121A	B	1	2	A
R1172S131A	B	1	3	A
R1172S141A	B	1	4	A
R1172S151A	B	1	5	A
R1172S161A	B	1	6	A
R1172S171A	B	1	7	A
R1172S181A	B	1	8	A
R1172S191A	B	1	9	A
R1172S201A	B	2	0	A
R1172S211A	B	2	1	A
R1172S221A	B	2	2	A
R1172S231A	B	2	3	A
R1172S241A	B	2	4	A
R1172S251A	B	2	5	A
R1172S261A	B	2	6	A
R1172S271A	B	2	7	A
R1172S281A	B	2	8	A
R1172S291A	B	2	9	A
R1172S301A	B	3	0	A
R1172S311A	B	3	1	A
R1172S321A	B	3	2	A
R1172S331A	B	3	3	A
R1172S341A	B	3	4	A
R1172S351A	B	3	5	A
R1172S181A5	B	0	1	A
R1172S281A5	B	0	2	A

Part Number	Product Code			
	①	②	③	④
R1172S081B	B	0	8	B
R1172S091B	B	0	9	B
R1172S101B	B	1	0	B
R1172S111B	B	1	1	B
R1172S121B	B	1	2	B
R1172S131B	B	1	3	B
R1172S141B	B	1	4	B
R1172S151B	B	1	5	B
R1172S161B	B	1	6	B
R1172S171B	B	1	7	B
R1172S181B	B	1	8	B
R1172S191B	B	1	9	B
R1172S201B	B	2	0	B
R1172S211B	B	2	1	B
R1172S221B	B	2	2	B
R1172S231B	B	2	3	B
R1172S241B	B	2	4	B
R1172S251B	B	2	5	B
R1172S261B	B	2	6	B
R1172S271B	B	2	7	B
R1172S281B	B	2	8	B
R1172S291B	B	2	9	B
R1172S301B	B	3	0	B
R1172S311B	B	3	1	B
R1172S321B	B	3	2	B
R1172S331B	B	3	3	B
R1172S341B	B	3	4	B
R1172S351B	B	3	5	B
R1172S181B5	B	0	1	B
R1172S281B5	B	0	2	B

Part Number	Product Code			
	①	②	③	④
R1172S081D	B	0	8	D
R1172S091D	B	0	9	D
R1172S101D	B	1	0	D
R1172S111D	B	1	1	D
R1172S121D	B	1	2	D
R1172S131D	B	1	3	D
R1172S141D	B	1	4	D
R1172S151D	B	1	5	D
R1172S161D	B	1	6	D
R1172S171D	B	1	7	D
R1172S181D	B	1	8	D
R1172S191D	B	1	9	D
R1172S201D	B	2	0	D
R1172S211D	B	2	1	D
R1172S221D	B	2	2	D
R1172S231D	B	2	3	D
R1172S241D	B	2	4	D
R1172S251D	B	2	5	D
R1172S261D	B	2	6	D
R1172S271D	B	2	7	D
R1172S281D	B	2	8	D
R1172S291D	B	2	9	D
R1172S301D	B	3	0	D
R1172S311D	B	3	1	D
R1172S321D	B	3	2	D
R1172S331D	B	3	3	D
R1172S341D	B	3	4	D
R1172S351D	B	3	5	D
R1172S181D5	B	0	1	D
R1172S281D5	B	0	2	D