

SIEMENS

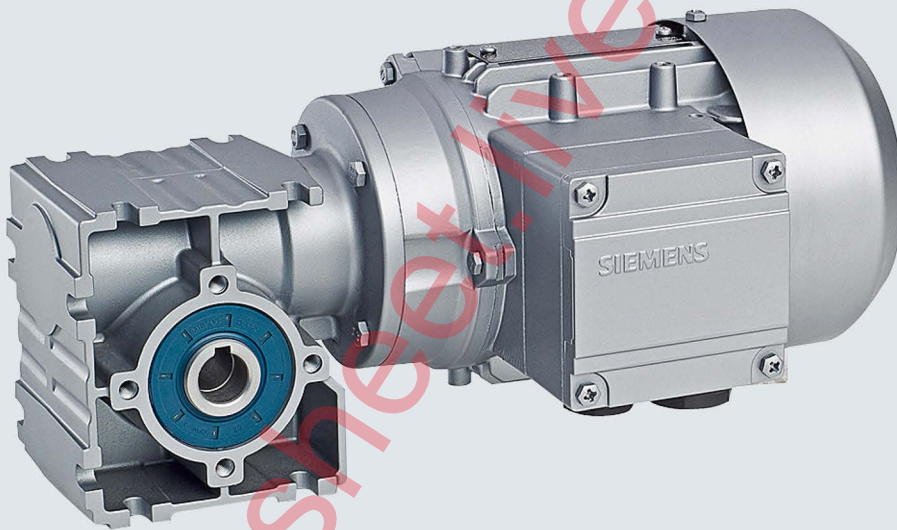

Operating Instructions

MOTOX

Worm Gearbox S

BA 2012

Edition

08/2018

siemens.com/gearedmotors

SIEMENS

MOTOX

Worm Gearbox S BA 2012

Operating Instructions

General information and safety notes	1
Technical description	2
Incoming goods, transport, and storage	3
Installation	4
Commissioning	5
Operation	6
Faults, causes and remedies	7
Service and maintenance	8
Disposal	9
Technical data	10
Spare parts	11
Explanations	12

Translation of the original instructions



08/2018

A5E38093971A/RS-AC

Legal information

Warning notice system

This manual contains notices you have to observe in order to ensure your personal safety, as well as to prevent damage to property. The notices referring to your personal safety are highlighted in the manual by a safety alert symbol, notices referring only to property damage have no safety alert symbol. These notices shown below are graded according to the degree of danger.

 DANGER
indicates that death or severe personal injury will result if proper precautions are not taken.
 WARNING
indicates that death or severe personal injury may result if proper precautions are not taken.
 CAUTION
indicates that minor personal injury can result if proper precautions are not taken.
NOTICE
indicates that property damage can result if proper precautions are not taken.

If more than one degree of danger is present, the warning notice representing the highest degree of danger will be used. A notice warning of injury to persons with a safety alert symbol may also include a warning relating to property damage.

Qualified Personnel

The product/system described in this documentation may be operated only by **personnel qualified** for the specific task in accordance with the relevant documentation, in particular its warning notices and safety instructions. Qualified personnel are those who, based on their training and experience, are capable of identifying risks and avoiding potential hazards when working with these products/systems.

Proper use of Siemens products

Note the following:

 WARNING
Siemens products may only be used for the applications described in the catalog and in the relevant technical documentation. If products and components from other manufacturers are used, these must be recommended or approved by Siemens. Proper transport, storage, installation, assembly, commissioning, operation and maintenance are required to ensure that the products operate safely and without any problems. The permissible ambient conditions must be complied with. The information in the relevant documentation must be observed.

Trademarks

All names identified by ® are registered trademarks of Siemens AG. The remaining trademarks in this publication may be trademarks whose use by third parties for their own purposes could violate the rights of the owner.

Disclaimer of Liability

We have reviewed the contents of this publication to ensure consistency with the hardware and software described. Since variance cannot be precluded entirely, we cannot guarantee full consistency. However, the information in this publication is reviewed regularly and any necessary corrections are included in subsequent editions.

Table of contents

1	General information and safety notes	5
1.1	General information	5
1.2	Copyright.....	7
1.3	Intended use	7
1.4	Obligations of the user	8
1.5	The five safety rules.....	9
1.6	Particular types of hazards	10
2	Technical description	11
2.1	General description.....	11
2.2	Cooling.....	11
2.3	Rating plate.....	11
2.4	Surface treatment	12
2.5	ATEX ignition hazards in accordance with DIN EN 80079-37.....	13
3	Incoming goods, transport, and storage	15
3.1	Incoming goods.....	15
3.2	Transport.....	15
3.3	Storage	16
4	Installation	17
4.1	Unpacking	17
4.2	General information on installation	17
4.3	Thread sizes and tightening torques for fastening bolts.....	19
4.4	Gearbox with foot mounting.....	20
4.5	Gearboxes in foot or flange version.....	20
4.6	Gearbox with C-type housing flange.....	21
4.7	Mounting an input or output element on the gearbox shaft	22
4.8	Removing and installing the protection cover.....	24
4.9	Installing and removing the shaft-mounted gearbox.....	25
4.9.1	General information on installing the shaft-mounted gearbox.....	25
4.9.2	Mounting the hollow shaft with feather key.....	26
4.9.3	Removing the hollow shaft.....	27
4.10	Torque arms with shaft-mounted gearboxes	28
4.11	Mounting the motor	30

5	Commissioning	31
6	Operation	33
7	Faults, causes and remedies	35
8	Service and maintenance	37
8.1	General notes about maintenance work	37
8.2	Checking the gearbox for leaks	38
8.3	Cleaning the gearbox or geared motor	39
8.4	Checking tightness of fastening bolts	39
9	Disposal	41
10	Technical data	43
10.1	General technical data	43
10.2	Weight	46
10.3	Mounting positions	46
11	Spare parts	47
12	Explanations	49
12.1	Declaration of Incorporation	49
12.2	EU Declaration of Conformity DIN EN 80079-36.....	50
12.3	EC/EU Declaration of Conformity	51

General information and safety notes

1.1 General information



ATEX version gearboxes

Instructions and measures that apply in particular to ATEX version gearboxes.

Note

Siemens AG does not accept any liability for damage and failures that result from the non-observance of these operating instructions.

These operating instructions are part of the gearbox delivery. Store the operating instructions near the gearbox.

These operating instructions apply to the standard version of the MOTOX worm gearbox S in sizes 08, 18, and 28.

Table 1- 1 Order number code

MOTOX gearbox	Structure of the order number position				
	1	2	3	4	5
Worm gearbox S	2	K	J	1	7

Note

In addition to these operating instructions, special contractual agreements and technical documentation apply to special gearbox designs and the associated supplementary equipment.

Please refer to the other operating instructions supplied with the product.

The described gearboxes correspond to the state-of-the-art at the time these operating instructions were printed.

Siemens AG reserves the right to change individual components and accessory parts in the interest of further development. The changes serve to improve the performance and safety. The significant features are retained. The operating instructions are updated regularly with new contents.

1.1 General information

The latest versions of the operating instructions, the declaration of incorporation and the declarations of conformity are available in electronic form in the Industry Online Support (<https://support.industry.siemens.com/cs/ww/de/ps/13424/man>).

You can find technical configuration data, spare parts lists and certificates of compliance on the Intranet at Once Delivered (https://c0p.siemens.com:8443/sie/1nce_delivered).

You can find the contact data of your Technical Support in the Database of contacts at Siemens AG (www.siemens.com/yourcontact).

If you have any technical questions, please contact Technical Support (<https://support.industry.siemens.com/cs/ww/en/sc/2090>).

Europe and Africa

Telephone: +49 911 895 7222

support.automation@siemens.com

America

Telephone: +1 800 333 7421

support.america.automation@siemens.com

Asia / Australia / Pacific

Telephone: +86 400 810 4288

support.asia.automation@siemens.com

Valid operating instructions for MOTOX

- BA 2010 - operating instructions for MOTOX gearboxes
- BA 2011 - operating instructions for MOTOX worm gearbox SC
- BA 2012 - operating instructions for MOTOX worm gearbox S
- BA 2019 - operating instructions for MOTOX input units
- BA 2310 - operating instructions for three-phase and single-phase AC motors and motors equipped with brake with accessories
- BA 2320 - operating instructions for LA/LG and LAI/LGI motors
- BA 2330 - operating instructions for LA/LE/LES motors
- BA 2510 - operating instructions for MOTOX optional add-on units
- BA 2515 - operating instructions for MOTOX gearboxes for overhead conveyors

1.2 Copyright

The copyright to these operating instructions is held by Siemens AG.

These operating instructions must not be wholly or partly reproduced for competitive purposes, used in any unauthorized way or made available to third parties without agreement of Siemens AG.

1.3 Intended use



ATEX version gearboxes

The ATEX gearbox satisfies the requirements of the Explosion Protection Directive 2014/34/EU.

In the case of ATEX version gearboxes, please observe instructions marked with this symbol.

The MOTOX worm gearboxes described in these operating instructions have been designed for stationary use in general machine engineering applications.

Unless otherwise agreed, the gearboxes have been designed for use in machinery and plants in industrial environments.

The gearboxes have been built using state-of-the-art technology and are shipped in an operationally reliable condition. Changes made by users could affect this operational reliability and are forbidden.

Note

The data on the rating plate assumes an installation altitude of up to 1 000 m above sea level.

The permissible ambient temperature is stamped on the rating plate.

For different installation altitudes and ambient temperatures, contact Technical Support.

The gearboxes have been designed solely for the application described in the Technical data (Page 43). Do not operate the gearboxes outside the specified power limits. Other operating conditions must be contractually agreed.

Do not climb on the gearbox. Do not place any objects on the gearbox.

1.4 Obligations of the user

The operator must ensure that all persons assigned to work on the geared motor have read and understood these operating instructions and that they follow them in all points in order to:

- Eliminate the risk to life and limb of users and other persons.
- Ensure the operational safety of the geared motor.
- Avoid disruptions and environmental damage through incorrect use.

Note the following safety information:

Shut down the geared motors and disconnect the power before you carry out any work on them.

Make sure that the drive unit cannot be turned on accidentally, e.g. lock the key-operated switch. Place a warning notice at the drive connection point which clearly indicates that work is in progress on the geared motor.

Carry out all work with great care and with due regard to "safety".

For all work, observe the relevant regulations for work safety and environment protection.

Read the instructions on the rating plates attached to the geared motor. The rating plates must be kept free from paint and dirt at all times. Replace any missing rating plates.

In the event of changes during operation, switch off the drive unit immediately.

Take appropriate protective measures to prevent accidental contact with rotating drive parts, such as couplings, gear wheels or belt drives.

Take appropriate protective measures to prevent accidental contact with parts and equipment that heat up to over +70 °C during operation.

When removing protective equipment, keep fasteners in a safe place. Re-attach removed protective equipment before commissioning.

Collect and dispose of used oil in accordance with regulations. Remove oil spillages immediately with an oil-binding agent in compliance with environmental requirements.

Do not carry out any welding work on the geared motor. Do not use the geared motor as a grounding point for welding operations.

Carry out equipotential bonding in accordance with applicable regulations and directives by electrotechnology specialists.

Do not use high-pressure cleaning equipment or sharp-edged tools to clean the geared motor.

Observe the permissible tightening torque of the fastening bolts.

Replace damaged bolts with new bolts of the same type and strength class.

Siemens AG accepts the warranty only for original spare parts.

The manufacturer who installs the geared motors in a plant must include the regulations contained in the operating instructions in its own operating instructions.

1.5 The five safety rules

For your own personal safety and to prevent material damage when carrying out any work, always observe the safety-relevant instructions and the following five safety rules according to EN 50110-1 Working in a voltage-free state. Apply the five safety rules in the sequence stated before starting work.

Five safety rules

1. Disconnect.
Also disconnect the auxiliary circuits, for example the anti-condensation heating.
2. Secure against reconnection.
3. Verify absence of operating voltage.
4. Ground and short circuit.
5. Cover or safeguard neighboring live parts.

After the work has been completed, undo the measures taken in the reverse order.

1.6 Particular types of hazards

 **WARNING**

Extreme surface temperatures

Hot surfaces over +55 °C pose a burn risk.

Cold surfaces below 0 °C pose a risk of damage due to freezing.

Do not touch the gearbox without protection.

 **WARNING**

Hot, escaping oil

Before starting any work wait until the oil has cooled down to below +30 °C.

 **WARNING**

Poisonous vapors when working with solvents

Avoid breathing in vapors when working with solvents.

Ensure adequate ventilation.

 **WARNING**

Risk of explosion when working with solvents

Ensure adequate ventilation.

Do not smoke!

 **WARNING**

Risk of eye injury

Rotating parts can throw off small foreign particles such as sand or dust.

Wear protective eyewear!

In addition to the prescribed personal protection gear, also wear suitable protective gloves and safety glasses.

Technical description

2.1 General description

The gearbox is supplied with one transmission stage.

The gearbox housing is made from die-cast aluminum.

The worm shaft is hardened and ground. The gear is manufactured from high-quality bronze.

All shafts are mounted in roller bearings.

The gearbox is lubricated for life with high-quality synthetic oil.

Radial shaft sealing rings are used in the standard version. At higher ambient temperatures over +40 °C to +80 °C, shaft sealing rings of temperature-resistant material are used, subject to contractual agreement.

2.2 Cooling

NOTICE
Dust deposits prevent heat radiation
Dust deposits prevent heat radiation and cause a high housing temperature.
Keep the gearbox free from dirt, dust, etc.

The gearbox does not normally require additional cooling. The generously dimensioned housing surface is sufficient for dissipating heat losses where there is free convection. If the housing temperature exceeds a value of +80 °C, please contact Technical Support.

2.3 Rating plate

The rating plate on the gearbox or geared motor is of coated aluminum foil. It is covered with a special masking film which ensures permanent resistance to UV radiation and media of all kinds, such as oils, greases, salt water and cleaning agents.

The adhesive and the material ensure firm adhesion and long-term legibility within the operating temperature range from -40 °C to +155 °C.

The edges of the rating plate are paint-finished to match the color of the gearbox or motor to which it is affixed.

In special cases, riveted or bolted metal plates are used.

2.4 Surface treatment

Standard-version gearboxes are not painted at the factory. If necessary, they can be painted with any kind of commercially available paint.



ATEX version gearboxes

As standard, the gearbox is not painted. The gearbox is optionally delivered complete with primer and paint finish.



ATEX version gearboxes

When applying conductive paint, the operating company must ensure that the paint remains in a perfect state. The paint finish must be checked at intervals of approximately 2 - 3 years.



ATEX version gearboxes

An excessively high electrostatic charge must be avoided. Ensure that highly active mechanisms that cause the paint finish to generate a charge are avoided.

Highly active mechanisms that can generate charges:

- Fast air with high dust content directed past the gearbox
- Sudden escape of compressed gases that contain particles
- Harsh abrasive processes (this does not mean manual cleaning / wiping with cleaning cloths)

WARNING

Danger due to electrostatic discharge

For paint finishes in explosion group III, the paint can be electrostatically charged as a result of intensive dust turbulence or processes with high levels of electrostatic charging.

Risk of explosion as a result of processes with high levels of electrostatic charging

Minimize the risk of electrostatic charging by applying effective measures according to IEC 60079-32-1.

NOTICE

Sealing lips must not come into contact with paint

Cover the shaft sealing rings.

2.5 ATEX ignition hazards in accordance with DIN EN 80079-37



ATEX version gearboxes

ATEX marking

Regardless of the type of protection, the letter »h« is always assigned. In addition to the marking on the rating plate, the valid types of protection below are applied:

Constructional safety "c"

The constructional safety is ensured by the selection of suitable materials and components, the dimensioning of the product for the customer's application, suitable sealing systems, adequate lubrication of rolling bearings, geared components and seals, and by thermal testing.

Liquid immersion "k"

The liquid immersion is achieved through oil bath lubrication. Refer to the rating plate and the Operating Instructions for the original oil filling.

Control of ignition sources "b"

Control of ignition sources is achieved by a temperature check and/or electrical oil level check.



ATEX version gearboxes

Servicing and maintenance work that are relevant for the type of protection shall only be carried out by SIEMENS service personnel or by SIEMENS authorized partners.

Incoming goods, transport, and storage

3.1 Incoming goods

NOTICE
Transport damage impairs correct functioning
Do not commission faulty gearboxes or geared motors.

Note

Do not open or damage parts of the packaging that preserve the product.

Note

Check that the technical specifications are in accordance with the purchase order.

Inspect the delivery immediately on arrival for completeness and any transport damage.

Notify the freight company of any damage caused during transport immediately (this is the only way to have damage rectified free of charge). Siemens AG will not accept any claims relating to items missing from the delivery and which are submitted at a later date.

The gearbox or geared motor is delivered in a fully assembled condition. Additional items are sometimes delivered packaged separately.

The products supplied are listed in the dispatch papers.

3.2 Transport

NOTICE
The use of force will damage the gearbox or geared motor
Transport the gearbox or geared motor carefully. Avoid knocks.
Before putting the drive into operation, remove any transport fixtures and keep them safe or render them ineffective. You can then use them again for transporting further items or you can apply them again.

Different forms of packaging may be used, depending on the size of the gearbox or geared motor and the method of transport. Unless contractually agreed otherwise, the seaworthy packaging complies with HPE Packaging Guidelines (Bundesverband Holzpackmittel Paletten Exportverpackungen e.V., the German Federal Association for wooden packaging, pallets, and export packaging).

3.3 Storage

Note the symbols which appear on the packaging. These have the following meanings:



This way up

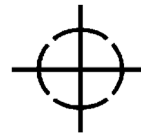

Center of gravity



Fragile



Do not use hand hook



Keep dry

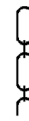

Attach here



Keep cool

3.3 Storage

 WARNING
Danger of serious injuries caused by falling objects
Danger of damage to the gearbox when stacked
Do not stack gearboxes or geared motors on each other.

NOTICE
Failure of the external protection
Mechanical damage, chemical damage and thermal damage, such as scratches, acids, alkalis, sparks, welding beads and heat cause corrosion.
Do not damage the paint finish.

Unless contractually agreed otherwise, the guarantee period for the standard preservative lasts 6 months from the date of delivery.

In the case of storage in transit over 6 months, special arrangements must be made for preservation. Please contact Technical Support.

Store the gearbox or geared motor in dry, dust-free rooms that are maintained at a constant temperature.

The storage location must be vibration- and shock-free.

The free shaft ends, sealing elements and flange surfaces must have a protective coating.

Installation

4.1 Unpacking

NOTICE
Transport damage impairs the correct function of the geared motor
Never commission faulty or defective motors.

Check the motor for completeness and damage. Report any missing parts or damage immediately.

Remove and dispose of the packaging material and transport equipment in compliance with regulations.

4.2 General information on installation



ATEX version gearboxes

Effect on bearings of stray electric currents from electrical equipment.

When mounting the gearbox on or connecting it to the machine, take care to ensure potential equalization. The information on grounding and equipotential bonding provided by the motor supplier must be observed.

 WARNING
Operating under load
Under load, the system can start or reverse in an uncontrolled fashion.
The entire system must be load-free so that there is no danger during this work.

NOTICE
Destruction caused by welding
Welding destroys the geared parts and bearings.
Do not weld on the gearbox. The gearbox must not be used as a grounding point for welding operations.

NOTICE
Overheating caused by solar radiation
Overheating of the gearbox due to exposure to direct sunlight. Provide suitable protective equipment such as covers or roofs. Prevent heat accumulation.

NOTICE
Malfunction resulting from foreign objects
The operator must ensure that no foreign objects impair the function of the gearbox.

NOTICE
Damaged components impair the correct function of the gearbox
If any components are damaged, the correct function of the gearbox will no longer be ensured. Do not install any damaged gearbox components.

NOTICE
Violation of the maximum permissible oil sump temperature
The oil sump temperature may be exceeded if the temperature monitoring equipment is incorrectly set. An alarm must be output when the maximum permissible oil sump temperature is reached. The geared motor must be switched off when the maximum permissible temperature is exceeded. If the geared motor is shut down, then this can cause the machine to come to a stop.

Exercise particular care during mounting and installation. The manufacturer cannot be held liable for damage caused by incorrect mounting and installation.

Make sure that there is sufficient space around the gearbox or geared motor for mounting, maintenance and repair.

On geared motors with a fan, leave sufficient free space for the entry of air. Observe the installation conditions for the geared motor.

Provide sufficient lifting gear at the start of mounting and fitting work.

Observe the mounting position specified on the rating plate. This ensures that the correct quantity of lubricant is provided.

Use all the fastening means that have been assigned to the particular mounting position and mounting type.

Cap bolts cannot be used in some cases due to a lack of space. In such cases, please contact Technical Support quoting the type of gearbox.

4.3 Thread sizes and tightening torques for fastening bolts

The general tolerance for the tightening torque is 10 %. The tightening torque is based on a friction coefficient of $\mu = 0.14$.

Table 4- 1 Tightening torques for fastening bolts

Thread size	Tightening torque for strength class		
	8.8	10.9	12.9
	[Nm]	[Nm]	[Nm]
M4	3	4	5
M5	6	9	10
M6	10	15	18
M8	25	35	41
M10	50	70	85
M12	90	120	145
M16	210	295	355
M20	450	580	690
M24	750	1 000	1 200
M30	1 500	2 000	2 400
M36	2 500	3 600	4 200

4.4 Gearbox with foot mounting

NOTICE
Do not subject the gearbox to excessive stress when tightening the fastening bolts
The foundation must be level and free from dirt.
The levelness deviation of the gearbox support must not exceed 0.1 mm.

The foundation should be designed in such a way that no resonance vibrations are created and no vibrations are transmitted from adjacent foundations.

The foundation structure on which the gearbox is to be mounted must be torsionally rigid. It must be dimensioned according to the weight and torque, taking into account the forces acting on the gearbox. If the substructure is too weak, it will cause radial or axial displacement, which cannot be measured at a standstill.

When using foundation blocks to fasten the gearbox to a concrete foundation, suitable recesses should be made in the foundation.

Align and grout the slide rails into the foundation.

Align the gearbox carefully with the units on the input and output side. Take into account the elastic deformation due to operating forces.

Prevent displacement from external forces due to lateral impacts.

Use stud bolts or headless screws of strength class 8.8 or higher for the foot mounting. Observe the tightening torque.

4.5 Gearboxes in foot or flange version

NOTICE
Impermissible housing loadings caused by incorrectly installed add-on elements
Do not subject the gearbox housing to excessive stress by adding add-on elements to the foot or flange.
Add-on elements must not transmit forces, torques, and vibrations to the gearbox.

To prevent strains on the housing, fasten the gearbox only on the flange or the foot fastening for force and torque transmission. Refer to Gearbox with foot mounting (Page 20).

The second mounting option (foot or flange) is intended for add-on elements, e.g. protection covers with an intrinsic weight of up to max. 30 % of the weight of the gearbox.

4.6 Gearbox with C-type housing flange

The gearbox with C-type housing flange is delivered ready for mounting on machines. It is mounted using an inner centering. The sealing rings are pressed in lower at both ends so that simple mounting is ensured.

Note

If the inserted sealing ring is located on the top of the gearbox, neither water nor dirt can collect. This is why we recommend the use of a protective cover (optional).

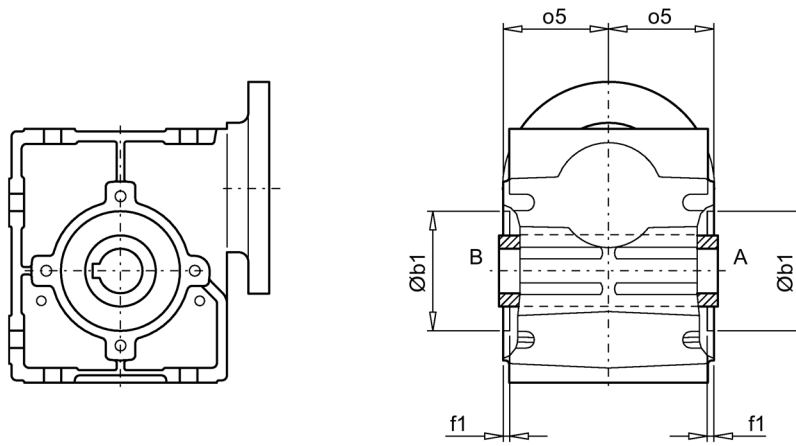



Figure 4-1 Press-in depth for mounting

Gearboxes	b1	f1	o5
S.08	Ø48 H7	3	40.0
S.18	Ø47 H8	3	47.5
S.28	Ø62 H7	3	58.0

4.7 Mounting an input or output element on the gearbox shaft

 WARNING
Risk of burns caused by hot parts Do not touch the gearbox without protection.

NOTICE
Damage to shaft sealing rings caused by solvent Avoid any contact of solvent or benzine with the shaft sealing rings.

NOTICE
Damage to shaft sealing rings caused by heating Use thermal shields to protect shaft sealing rings from heating above 100 °C due to radiant heat.

NOTICE
Premature wear or material damage due to misalignment Misalignment caused by excessive angular or axis displacement to the connecting shaft ends. Ensure precise alignment of the individual components.

NOTICE
Damage caused by improper handling Bearings, housing, shaft and locking rings are damaged due to improper handling. Do not use impacts or knocks to force the input and output elements to be mounted onto the shaft.

Note

Deburr the parts of elements to be fitted in the area of the hole or keyways.
Recommendation: 0.2 x 45°

Where couplings are to be fitted in a heated condition, observe the specific operating instructions for the coupling. Unless otherwise specified, apply the heat inductively using a torch or in a furnace.

Use the center holes in the shaft end faces.

Use a fitting device to fit the input or output elements.

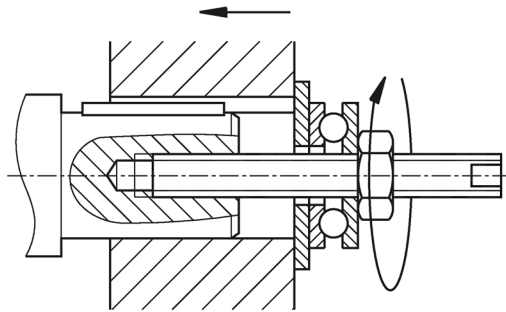
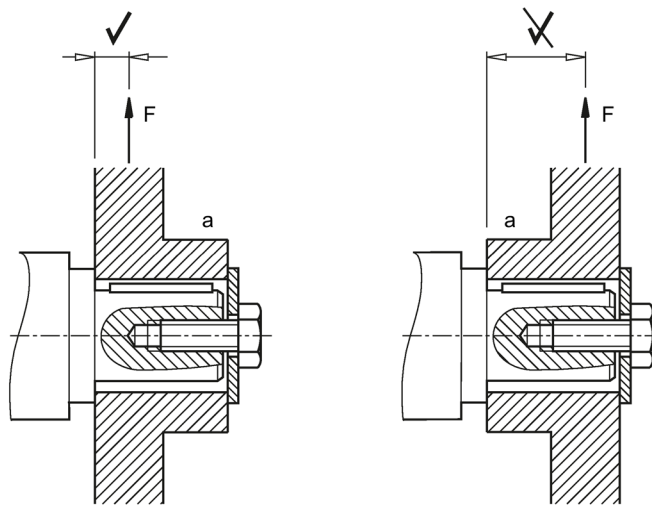

Figure 4-2 Example of a fitting device

Observe the correct mounting arrangement to minimize stress on shafts and bearings due to lateral forces.

Correct

Incorrect



a Hub

F Force

Figure 4-3 Mounting arrangement for low stress on shafts and bearings

Procedure

1. Use either benzine or solvent to remove the anti-corrosion protection from the shaft ends and flanges or remove the applied protective skin.
2. Fit the drive input and output elements to the shafts. Fasten the elements when necessary.

You have now fitted the input or output element.

4.8 Removing and installing the protection cover

The protection cover is delivered ready-fitted to the gearbox flange. The protection cover must be removed in order to fit the output shaft.

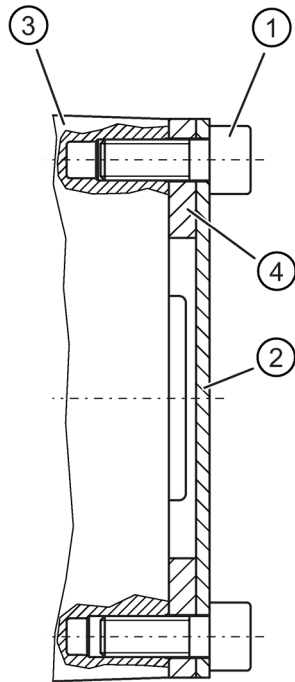

- ① Screw
- ② Protection cover
- ③ Gearbox housing
- ④ Sealing ring

Figure 4-4 Protection cover

Procedure

1. Undo the screws ① and remove the protection cover ②.
2. Fit the output shaft.
3. Using a suitable cleaning agent, clean the contact surface of the protection cover ② on the gearbox.

You have now installed the protection cover for operation.

4.9 Installing and removing the shaft-mounted gearbox

4.9.1 General information on installing the shaft-mounted gearbox

NOTICE
Damage to shaft sealing rings caused by solvent
Avoid any contact of solvent or benzine with the shaft sealing rings.

NOTICE
Subjecting stress to the hollow shaft causes bearing failure
Skewing or stressing the hollow shaft increases the loading. This can cause bearing failure.
The hollow shaft must be flush with the machine shaft to avoid misalignment.
Do not subject the hollow shaft to axial and radial stress.

Note

Coat the contact surfaces with the mounting paste supplied with the product or any suitable lubricant to prevent frictional corrosion.

Note

Observe the permissible concentricity tolerance of the cylindrical shaft end of the machine shaft to the housing axle according to DIN 42955.

4.9.2 Mounting the hollow shaft with feather key

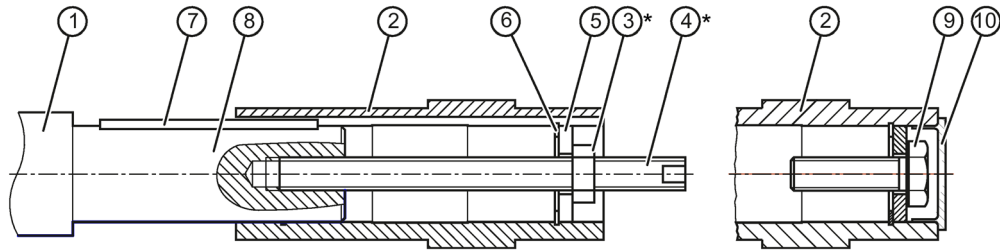

* Not included in scope of supply

- ① Machine shaft / plug-in shaft
- ② Hollow shaft
- ③ Hexagon nut
- ④ Threaded spindle
- ⑤ Disk
- ⑥ Circlip
- ⑦ Feather key
- ⑧ Mounting paste
- ⑨ Screw
- ⑩ Sealing caps

Figure 4-5 Mounting the hollow shaft with feather key

Procedure

1. Use benzine or a solvent to remove the anti-corrosion protection from the shaft ends and flanges.
2. Check the seats or edges of the hollow and machine shaft / plug-in shaft for damage. Contact Technical Support if you notice any damage.
3. Apply the mounting paste ⑦ to the machine shaft / plug-in shaft ①. Apply the paste uniformly.
4. Fit the gearbox using the disk ⑤, threaded spindle ④ and nut ③. Support is provided by the hollow shaft ②.
5. Replace the nut ③ and the threaded spindle ④ with a screw ⑨. Tighten the screw ⑨ to the specified torque.
6. Close the open hollow shaft end using a sealing cap ⑩.

You have now mounted the hollow shaft with feather key.

Table 4-2 Tightening torque for the screw

Thread size	M5	M6	M8	M10
Tightening torque [Nm]	5	8	8	14

4.9.3 Removing the hollow shaft

! WARNING

Inadequately secured gearbox or geared motors can free themselves

Before driving out the machine shaft, fasten a suitably dimensioned means of absorbing load to the gearbox.

Slightly pretension the pulling equipment so that the gearbox does not drop onto it when the plug-in shaft is released.

NOTICE

Subjecting stress to the hollow shaft causes bearing failure

It is essential to prevent misalignment when removing the unit.

Note

If frictional corrosion has occurred on the seat surfaces, use rust solvent to facilitate the removal of the gearbox. Allow an adequately long time for the rust solvent to take effect.

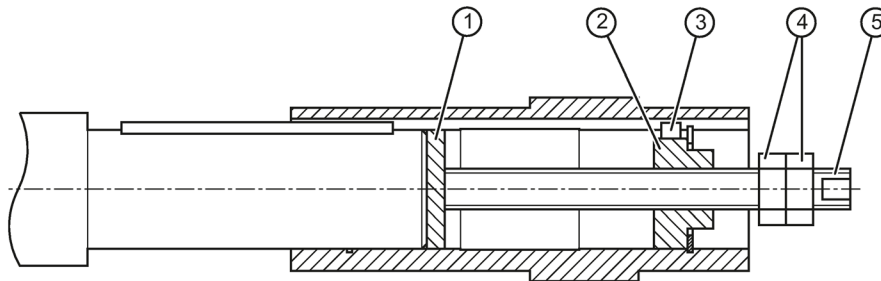

Items ① to ⑤ are not included in the scope of supply.

- ① Disk
- ② Threaded block
- ③ Parallel key
- ④ Hexagon nut
- ⑤ Threaded spindle

Figure 4-6 Removing the hollow shaft with parallel key

Procedure

1. Remove the axial locking element from the hollow shaft.
2. Drive out the machine shaft using the disk ①, threaded block ②, parallel key ③, threaded spindle ⑤ and hexagon nuts ④.

You have now removed the hollow shaft.

4.10 Torque arms with shaft-mounted gearboxes

Design suggestion for threaded block and disk

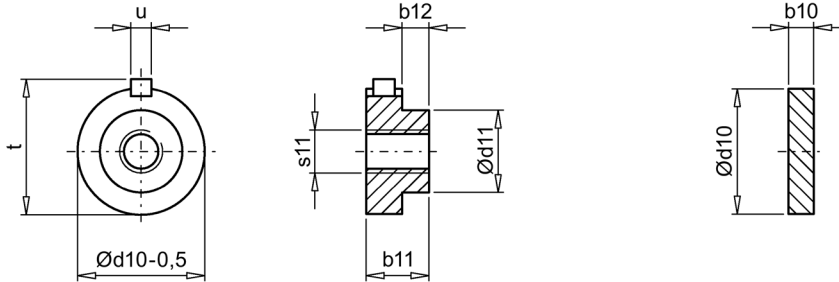

Frame size	b10	b11	b12	d10	d11	s11	t _{max}	u
	[mm]	[mm]	[mm]	[mm]	[mm]		[mm]	[mm]
08	3	5	-	15.9	-	M5	18	5
18	3	6	-	17.9	-	M6	20.5	6
28	3	15	10	19.9	10	M6	22.5	6
				24.9	14	M8	28	8

4.10 Torque arms with shaft-mounted gearboxes

Torque arms can absorb the reaction torque and the weight force of the gearbox.



ATEX version gearboxes

Worn or irreparably damaged rubber elements do not function properly.

Impacts can cause sparks.

Damaged rubber elements must be replaced immediately.

NOTICE

Dangerous transient torques due to excess backlash

Take care to prevent the torque arm from causing excessive constraining forces, e.g. due to the driven shaft running out-of-true.

NOTICE

Impermissible gearbox loading caused by incorrect mounting

Do not tension torque arms when mounting.

The torque arm bush must be supported by bearings on both sides.

NOTICE**Damage to the rubber elements caused by solvent**

Solvents, oils, greases, and fuels damage rubber elements.

Avoid contact at all times.

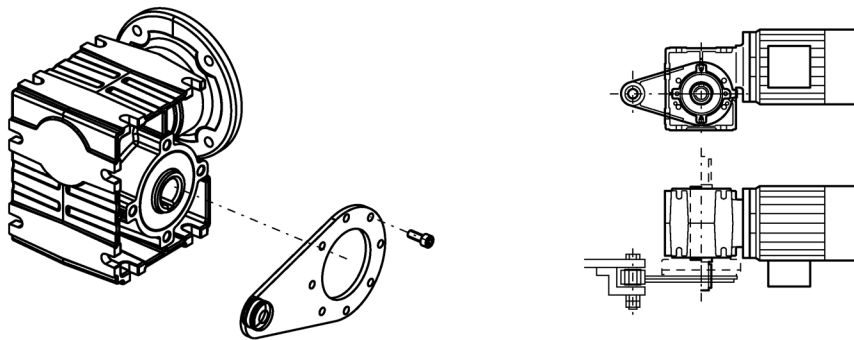

Figure 4-7 Attaching the torque arm

The torque arm can be fitted in various positions, depending on the hole circle pitch.

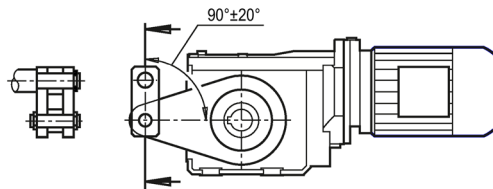

Figure 4-8 Toggle lever design

For a toggle lever design, derive the force in the range of $90^\circ \pm 20^\circ$.

Procedure

1. Clean the contact surfaces between the housing and the torque arm.
2. Tighten the M6 screws to 10 Nm torque.

You have now mounted the torque arm.

4.11 Mounting the motor

NOTICE

Moisture penetrates an inadequately sealed geared motor

If the geared motor is to be installed outdoors or for an installation requiring a high degree of protection (\geq IP55):

- Seal the flange, screws or integrated elements using an appropriate sealing compound.
- The flange-mounted motor must be sealed across the entire contact surface.
- Seal the geared motor in the outer area.

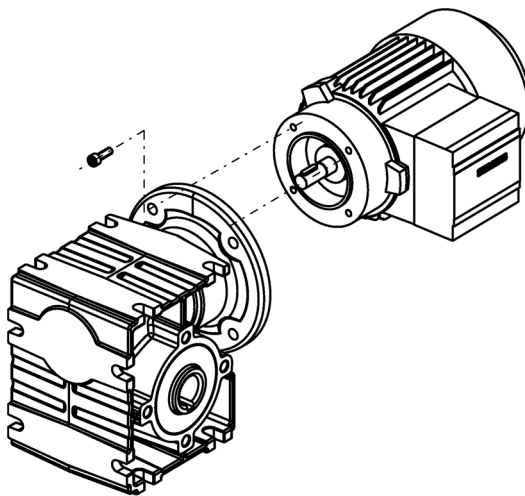





Figure 4-9 Motor assembly

 WARNING
Unintentional starting of the drive unit Secure the drive unit to prevent it from being started up unintentionally. Attach a warning notice to the start switch.

 WARNING
Risk of slipping on oil Remove any oil spillage immediately with an oil-binding agent in compliance with environmental requirements.

 WARNING
Hazardous voltage and rotating parts Before starting commissioning, mount the covers required for the correct air guidance. Avoid contact with active, live or rotating parts.

Procedure

After mounting, the geared motor is ready for use.

1. Run the geared motor for a short period of time under no-load operation.
2. Check for any irregularities such as oil leakages, strong vibration and noise.
3. Switch in the load.

You have now started up the geared motor.



ATEX version gearboxes

The difference between the temperature of the housing and the ambient temperature of max. +40° C must not exceed 70 K.

Using a suitable temperature sensor, measure the temperature at the lowest point of the housing (oil sump) or at the mounting surface in the case of output units. We recommend that you monitor the gearbox temperature indirectly by monitoring the motor current.

Changes are an indication of possible incipient damage.

CAUTION

Malfunctions can cause injuries or gearbox damage

In the event of changes during operation, the drive unit must be switched off immediately.

Determine the cause of the fault using the fault table (Page 35). Remedy faults or have faults remedied.

Check the gearbox during operation for:

- Excessive operating temperature
- Changes in gear noise
- Possible oil leakage at the housing and shaft seals

Faults, causes and remedies

Note

Faults and malfunctions that occur during the warranty period and requiring repair work on the gearbox must be remedied only by Technical Support. If faults occur without a clearly identifiable cause, Siemens AG recommends the services of the Technical Support even after the warranty period has elapsed.

If you need the help from the Technical Support, please have the following information ready:

- Rating plate data
 - Nature and extent of the fault
 - Suspected cause
-

Table 7- 1 Faults, causes and remedies

Faults	Causes	Remedy
Unusual noise on the gearbox.	Excessive bearing play and / or bearing defective.	Check the bearing and replace if necessary.
	Defective gearing.	Check the gearing and replace if necessary.
	Fastening bolts loose.	Checking tightness of fastening bolts (Page 39).
	Excessive external load on the drive input and output.	Check the load against rated data (you might need to correct the belt tension, for example).
	Transport damage.	Check the gearbox for damage in transit.
	Damage due to blockage during commissioning.	Call Technical Support.
Unusual noise from the drive unit.	Excessive bearing play and / or bearing defective.	Check the bearing and replace if necessary.
	Fastening bolts loose.	Checking tightness of fastening bolts (Page 39).
Unusual motor noise.	Excessive bearing play and / or bearing defective.	Check the bearing and replace if necessary.
	Motor brake is rubbing.	Check air gap and adjust if necessary.
	Converter parameterization.	Correct the parameterization.

Faults	Causes	Remedy
Oil escapes.	Shaft sealing rings defective.	Replace the shaft sealing rings.
	Cover / flange bolts loose.	Checking tightness of fastening bolts (Page 39). Continue to monitor the gearbox.
	Surface sealing defective (e.g. on cover, flange).	Reseal.
	Damage in transit (e.g. hairline cracks).	Check the gearbox for damage in transit.
	Frequent cold starts during which the oil foams up.	Call Technical Support.
Gearbox overheats.	Motor fan cover and / or gearbox very dirty.	Clean the fan cover and surface of the geared motor (Page 39).
	Excessive bearing play and / or bearing defective.	Check the bearing and replace if necessary.
	Power or speed too high	Adhere to data on rating plate.
Geared motor only starts with difficulty or not at all.	Excessive external load on the drive input and output.	Check the load against rated data (you might need to correct the belt tension, for example).
	Motor brake is not released.	Check circuit / connection of brake. Check brake for wear and readjust if necessary.
Excessive play at drive input and output.	Flexible elements worn (e.g. on couplings).	Replace flexible elements.
	Positive connection disrupted by overload.	Call Technical Support.

Service and maintenance

8.1 General notes about maintenance work



ATEX version gearboxes

All measures, checks, and their results must be documented by the operator and records kept in a safe place for 10 years.

! WARNING
Unintentional starting of the drive unit
Secure the drive unit to prevent it from being started up unintentionally. Attach a warning notice to the start switch.

NOTICE
Improper maintenance
Only authorized qualified personnel may perform the maintenance and servicing. Only original parts supplied by Siemens AG may be installed.

Note

The gearbox is lubricated for life.
Lubricant changes are not required.

Only qualified personnel may perform the inspection, maintenance and servicing work. Please observe the General information and safety notes (Page 5).

Table 8- 1 Maintenance measures

Measure	Time interval	Description of the work
Monitor and check the geared motor for unusual noise, vibrations, and changes.	Daily; if possible, more frequently during operation.	Operation (Page 33)
Check the housing temperature.	After 3 hours, on the first day, thereafter monthly.	
Check the gearbox for leaks.	After the first day, thereafter monthly.	Checking the gearbox for leaks (Page 38)

8.2 Checking the gearbox for leaks

Measure	Time interval	Description of the work
Clean the geared motor.	Depending on degree of soiling, at least every 6 months.	Cleaning the gearbox or geared motor (Page 39)
Check that fastening screws on gearboxes and add-on elements are securely tightened. Check that covers and plugs are securely fastened.	After 3 hours, and then every 2 years.	Checking tightness of fastening bolts (Page 39)
Check the torque arm's plastic bushing.	Every 6 months.	Torque arms with shaft-mounted gearboxes (Page 28)

8.2 Checking the gearbox for leaks

Oil or grease escaping in small quantities from the shaft sealing ring should be regarded as normal during the running-in phase of 24 hours operating time.

If the quantities escaping are significant or leaking continues after the running-in phase, the shaft sealing ring must be replaced to prevent consequential damage.

Shaft sealing rings are subject to natural wear. The service life depends on the operating conditions. We recommend that shaft sealing rings are included in periodic maintenance and servicing work on the system.

Table 8-2 Description and measures

Status	Description	Measures	Notes
Film of moisture on the shaft sealing ring	Film of moisture as a result of the inherent principle of operation (apparent leakage)	Remove using a clean cloth and continue to observe.	This does not represent a fault; frequently, in the course of operation, the sealing ring dries off.
Leakage at the shaft sealing ring	Identifiable small trickle, formation of drops, also after the running-in phase	Replace the sealing ring, determine the possible cause of the sealing ring failure and rectify.	During the running-in phase, the shaft sealing ring beds into the shaft. A visible track can be seen on the shaft. Optimum preconditions for a perfect seal are obtained after the running-in phase.

8.3 Cleaning the gearbox or geared motor

NOTICE
Dust deposits cause higher housing temperatures Dust deposits prevent heat radiation. Keep the geared motor free from dirt and dust.

NOTICE
Cleaning with a high-pressure cleaning appliance Water can penetrate into the geared motor. Seals can become damaged. Do not use a high-pressure cleaning appliance to clean the geared motor. Do not use tools with sharp edges.

Switch off the power supply to the drive unit before cleaning it.

8.4 Checking tightness of fastening bolts



ATEX version gearboxes

Loose parts can cause sparks through impact.

Entry of foreign bodies can cause sparks.

Note

Replace damaged headless bolts with new bolts of the same type and strength class.

Switch off the power supply to the drive unit. Check all fastening bolts for tightness using a torque wrench.

8.4 Checking tightness of fastening bolts

The general tolerance for the tightening torque is 10 %. The tightening torque is based on a friction coefficient of $\mu = 0.14$.

Table 8- 3 Tightening torques for fastening bolts

Thread size	Tightening torque for strength class		
	8.8	10.9	12.9
	[Nm]	[Nm]	[Nm]
M4	3	4	5
M5	6	9	10
M6	10	15	18
M8	25	35	41
M10	50	70	85
M12	90	120	145
M16	210	295	355
M20	450	580	690
M24	750	1 000	1 200
M30	1 500	2 000	2 400
M36	2 500	3 600	4 200



Recycling and disposal of MOTOX geared motors

For environmentally friendly recycling and disposal of your old device, please contact a company certified for the disposal of old electrical and/or electronic devices and dispose of the device in accordance with the regulations in your country.

WARNING
Used oil disposal
Incorrect disposal of used oil is a threat to the environment and health.
After use, oil must be taken to a used oil collection point. The addition of foreign substances such as solvents, brake and cooling fluid is prohibited.
Avoid prolonged contact with the skin.

Empty the used oil from the gearbox. The used oil must be collected, stored, transported and disposed of in accordance with regulations. Do not mix polyglycols with mineral oil. Dispose of polyglycols separately.

Please observe country-specific laws. Under German law, to allow optimal treatment of the oil (§4 VI Used Oil), oils with different disposal codes must not be mixed with one another.

Collect and dispose of used oil in accordance with regulations.

Remove oil spillages immediately with an oil-binding agent in compliance with environmental requirements.

Dispose of the housing parts, motor parts, gear wheels, shafts and roller bearings of the geared motor as scrap metal.

Dispose of packaging material in accordance with regulations.

Table 9- 1 Disposal codes for gear oils

Type of oil	Designation	Disposal code
Polyglycols	CLP ISO PG VG460, CLP ISO PAO VG22, CLP ISO H1 VG460	13 02 08

Technical data

10.1 General technical data

The most important technical data appears on the rating plate of the gearboxes and geared motors.

This data, together with the contractual agreements for the geared motors, determines the limits of intended use.

In the case of geared motors, a rating plate attached to the motor usually indicates the data for the entire drive.

In certain cases separate rating plates are mounted on the gearbox and the motor.

SIEMENS				IEC60034	SIEMENS		1	2
XYK0412/8999999 nnn				CE				3
2KJ1506-5JR13-2FD1-Z				(IM)H-01-A				4
KAF108-LA160L4-L150/100GH								5
IP55		254kg Tamb -20...+40°C					9	6
K-ID: 1234567890							10	7
6.2L OIL CLP PG VG220 i: 12.9								8
50Hz		n2: 113r/min 60Hz		n2: 136r/min				9
T2: 1266Nm		fB: 1.5 T2: 1264Nm		fB: 1.5				10
3~Mot. ThCl.155(F)		TP-PTC		100 Nm		190-240V AC		11
50Hz		400/690V D/Y		60Hz		460V Y		12
29/16.74A		cosφ 0.84		28.6A		cosφ 0.87		13
15kW S1 IE1-90%		1460r/min		15kW S1 IE1-92,4%		1755r/min		14
Mot. 1LA7166-4AA								15
SIEMENS AG, DE-72072 Tuebingen / Made in Germany								16
								17
								18
								19
								20
								21
								22
								23
								24
								25
								26
								27
								28
								29
								30
								31
								32
								33
								34
								35
								36
								37
								38
								39
								40
								41
								42
								43
								44
								45
								46
								47
								48
								49

Figure 10-1 Rating plate example

- 1 Data matrix code
- 2 Applicable standard
- 3 Factory serial number
- 4 CE marking or other marking, if required
- 5 Article number
- 6 Type designation
- 7 Mounting position
- 8 Degree of protection acc. to IEC 60034-5
- 9 Weight m [kg]
- 10 Ambient temperature
- 11 Customer ID
- 12 Oil quantity [l] main gearbox / intermediate gearbox + extruder flange
- 13 Type of oil
- 14 Oil viscosity ISO VG class to DIN 51519 / ISO 3448
- 15 Total transmission ratio i

10.1 General technical data

Frequency 1

- 16 Rated frequency f [Hz]
- 17 Gearbox output speed n_2 [rpm]
- 18 Geared motor output torque T_2 [Nm]
- 19 Service factor f_B

Frequency 2

- 20 Rated frequency f [Hz]
- 21 Gearbox output speed n_2 [rpm]
- 22 Geared motor output torque T_2 [Nm]
- 23 Service factor f_B

Motor and brake data

- 24 Phase number and type of current for the motor
- 25 Temperature class Th.Cl.
- 26 Motor protection (TP)
- 27 Symbols (IEC 60617-2): \square = brake
- 28 Rated braking torque T_{Br} [Nm]
- 29 Brake supply voltage U [V]

Frequency 1

- 30 Rated frequency f [Hz]
- 31 Rated voltage / range U [V]
- 32 Circuit, graphic symbols according to DIN EN 60617 Part 6 / IEC 60617-6
- 33 Rated current I_N [A]
- 34 Power factor $\cos \varphi$
- 35 Rated output P_N [kW]
- 36 Duty type
- 37 Efficiency class marking according to IEC 60034-30
- 38 Rated speed n_N [rpm]

Frequency 2

- 39 Rated frequency f [Hz]
- 40 Rated voltage / range U [V]
- 41 Circuit, graphic symbols according to DIN EN 60617 Part 6 / IEC 60617-6
- 42 Rated current I_N [A]
- 43 Power factor $\cos \varphi$
- 44 Rated output P_N [kW]
- 45 Duty type
- 46 Efficiency class marking according to IEC 60034-30
- 47 Rated speed n_N [rpm]
- 48 Motor designation
- 49 Country of origin

Rating plate for ATEX version gearboxes



SIEMENS XYK1804/8999999 nnn 2KJ3406-5EA04-0DG1-Z FDAD88-K4-(90)				 		SIEMENS		1	2	3
K-ID: 1234567890 71.1kg Tamb -15...+40°C		(IM)M4 II 2G Ex h IIC T4 Gb II 2D Ex h IIC T120°C Db								7
11.0L OIL CLP VG220 i: 188.00 n2max: 8.0r/min		n1: 1465r/min						8	9	10.1
T2max: 1317Nm fB: 1.4 T1: 11.16 Nm		SIEMENS AG, DE-72072 Tuebingen / Made in Germany						12	13	14
								15	16	10.2
								17	18	19
								18	20	
								SIEMENS AG, DE-72072 Tuebingen /		21

Figure 10-2 ATEX rating plate fitted



SIEMENS XYK1804/8999999 nnn 2KJ3406-5EA04-0DG1-Z FDAD88-K4-(90)				(IM)M4		SIEMENS		1		
K-ID: 1234567890 71.1kg Tamb -15...+40°C										7
11.0L OIL CLP VG220 i: 188.00 n2max: 8.0r/min		n1: 1465r/min						8	9	
T2max: 1317Nm fB: 1.4 T1: 11.16 Nm		SIEMENS AG, DE-72072 Tuebingen / Made in Germany						12	13	14
								15	16	19
								17	18	20
								SIEMENS AG, DE-72072 Tuebingen /		21

Figure 10-3 ATEX rating plate, supplied separately packed

- 1 Data matrix code
- 2  marking
- 3 CE marking
- 4 Factory serial number
- 5 Article number
- 6 Type designation
- 7 Mounting position
- 8 Weight m [kg]
- 9 Ambient temperature
- 10.1 Type of protection gas
- 10.2 Type of protection dust
- 11 Customer ID
- 12 Oil quantity [l] main gearbox / intermediate gearbox
- 13 Type of oil
- 14 Oil viscosity ISO VG class according to DIN 51519 / ISO 3448
- 15 Total transmission ratio i
- 16 Gearbox output speed n_{2max} [rpm]
- 17 Geared motor output torque T_{2max} [Nm]
- 18 Service factor f_B
- 19 Gearbox input speed n_1 [rpm]
- 20 Geared motor input torque T_1 [Nm]
- 21 Country of origin

10.2 Weight

The weight of the entire geared motor is given in the shipping papers.

The weight is stated on the rating plate of the motor, gearbox or geared motor.

The weight specification refers only to the product in the delivery state.

10.3 Mounting positions

The type of construction designations are compliant with IEC 60034-7 (Code I).

The lubrication for life has been designed to enable the gearbox to be operated in all the types of construction and mounting positions shown.

S B3-00 (IM B3-00)
SZ, SF B5-01 (IM B5-01)
SA H-01

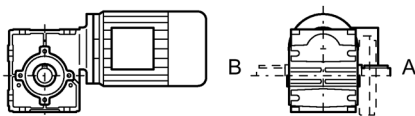

S B8-00 (IM B8-00)
SZ, SF B5-03 (IM B5-03)
SA H-02

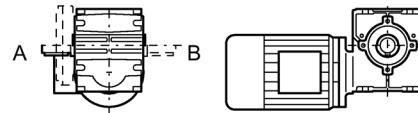

S B6-00 (IM B6-00)
SZ, SF B5-00 (IM B5-00)
SA H-04

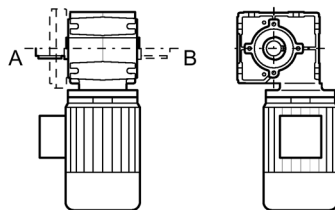

S B7-00 (IM B7-00)
SZ, SF B5-02 (IM B5-02)
SA H-03

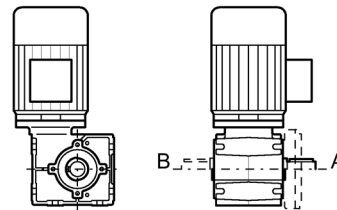

S V5-00 (IM V5-00)
SZ, SF V1-00 (IM V1-00)
SA H-05

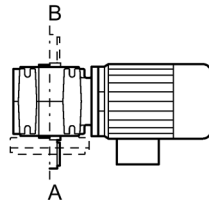

S V6-00 (IM V6-00)
SZ, SF V3-00 (IM V3-00)
SA H-06

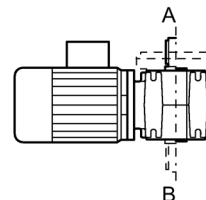

A, B Position of insert shaft/solid shaft

Figure 10-4 Type of construction options for S sizes 08, 18, 28

Spare parts

By stocking the most important spare and wearing parts on site, you can ensure that the gearbox or geared motor is ready for use at any time.

<p>NOTICE</p> <p>Safety impairment caused by inferior products</p> <p>The installation and/or use of inferior products can have a negative impact on the design characteristics of the geared motor and might consequently impair the active and/or passive safety features of the machine.</p> <p>Siemens AG states explicitly that only spare parts and accessories supplied by Siemens have been tested and approved by Siemens AG.</p> <p>If you do not use original spare parts and original accessories, Siemens AG excludes every liability and warranty.</p> <p>Siemens AG accepts the warranty only for original spare parts.</p>
--

Note that special manufacturing and delivery specifications often apply to individual components. All spare parts offered by Siemens AG are state-of-the-art and conform to the latest legal regulations.

Please supply the following data when ordering spare parts:

- Serial number shown on the rating plate ③
- Type designation shown on the rating plate ⑥
- Part number
 - 3-digit position number from the spare parts list
 - 6-digit part number
 - 7-digit article number
 - 14-digit material number
- Quantity



<p>SIEMENS  IEC60034 XYK0412/8999999 nnn 2KJ1506-5JR13-2FD1-Z KAF108-LA160L4-L150/100GH (IM)H-01-A IP55 254kg Tamb -20...+40°C K-ID: 1234567890</p> <hr/> 6.2L OIL CLP PG VG220 i: 12.9 50Hz n2: 113r/min 60Hz n2: 136r/min T2: 1266Nm fB: 1.5 T2: 1264Nm fB: 1.5 <hr/> 3-Mot. ThCl.155(F) TP-PTC  100 Nm 190-240V AC 50Hz 400/690V D/Y 60Hz 460V Y 29/16.74A cosφ 0.84 28.6A cosφ 0.87 15kW S1 IE1-90% 1460r/min 15kW S1 IE1-92,4% 1755r/min Mot. 1LA7166-4AA SIEMENS AG, DE-72072 Tuebingen / Made in Germany	<p>SIEMENS 1 2</p> <p>3 4</p> <p>5 6</p> <p>7 8 9 10</p> <hr/> <p>11 12 13 14 15 17 20 21</p> <p>16 19 22 23</p> <hr/> <p>24 25 26 27 28 29</p> <p>30 31 32 39 40 41</p> <p>33 34 42 43</p> <p>35 36 37 38 44 45 46 47</p> <p>48</p> <p>SIEMENS AG, DE-72072 Tuebingen / 49</p>
--	--

Figure 11-1 Example of a MOTOX rating plate

For motors with their own rating plate, the spare parts documentation in the original operating instructions applies.

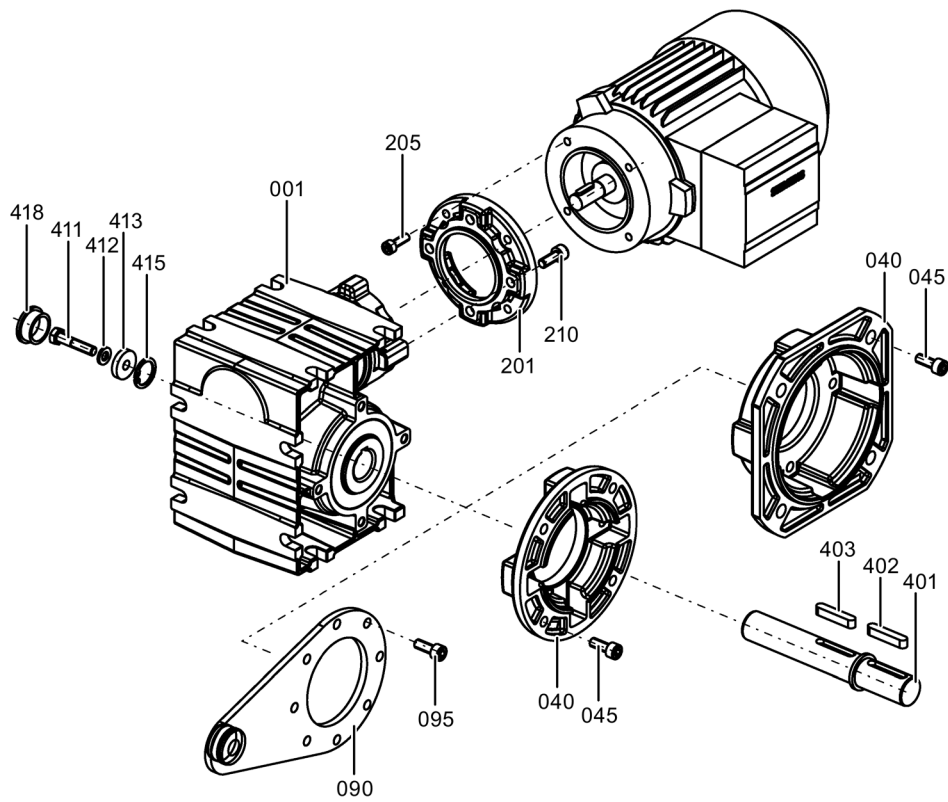

- 001 Gearbox housing
- 040 Flange
- 045 Screw
- 090 Torque arm
- 095 Screw
- 201 Flange
- 205 Screw
- 210 Screw
- 401 Insert shaft
- 402 Parallel key
- 403 Parallel key
- 411 Screw
- 412 Disk
- 413 Disk
- 415 Locking ring
- 418 Sealing cap

Figure 11-2 Worm gearbox S sizes 08, 18, 28

Explanations

12.1 Declaration of Incorporation

Document No. A5E37802169AB

Declaration of Incorporation according to Directive 2006/42/EC Annex II 1 B.

Manufacturer: Siemens AG
 Division Digital Factory DF MC

Address: Bahnhofstraße 40, 72072 Tübingen, Germany

Product designation: MOTOX gearboxes with input units A, K, P

- Worm gearboxes S.08, S.18, S.28

The designated product is an incomplete machine in the sense of Article 2 g of Directive 2006/42/EC. It is designed exclusively for incorporation into another machine or for assembly with one or more other machines.

The following essential safety and health requirements of Directive 2006/42/EC, Annex I, are applied for the incomplete machine specified above and are complied with. The risks not relevant for the product are not listed.

- 1.1.1, 1.1.2, 1.1.3, 1.1.5
- 1.2.4.4, 1.2.6
- 1.3.1, 1.3.2, 1.3.3, 1.3.4, 1.3.6, 1.3.8.1
- 1.4.1, 1.4.2, 1.4.2.1
- 1.5.1, 1.5.2, 1.5.4, 1.5.5, 1.5.6, 1.5.8, 1.5.9, 1.5.10, 1.5.11, 1.5.13, 1.5.15
- 1.6.1, 1.6.2
- 1.7.1, 1.7.1.1, 1.7.2, 1.7.3, 1.7.4, 1.7.4.1, 1.7.4.2, 1.7.4.3

When developing and manufacturing the above designated product, the following standards and specifications were applied: EN ISO 12100-1: 2011

The special technical documents according to Annex VII, B of the Directive 2006/42/EC were generated and will be provided to the appropriate authorities when justifiably requested in an electronic form.

The named person for compiling the technical documents:
 Georg Böing, Head of Research & Development

Before the final product is commissioned, in which the incomplete machine described here is to be incorporated, it must be ensured that this is in conformance with Directive 2006/42/EC.

Tübingen, July 1, 2017

Georg Böing
 Head of Research & Development

Florian Hanisch
 Vice President Lead Factory Simogear

12.2 EU Declaration of Conformity DIN EN 80079-36

Document No. A5E43968684AA

Manufacturer: Siemens AG
Division Digital Factory DF MC
Address: Bahnhofstraße 40, 72072 Tübingen, Germany
Product designation: MOTOX gearbox series
Gearbox types: S
Sizes: 08 - 28
Input units: K









The designated product complies with the regulations of the following European Directive:

Directive 2014/34/EU, OJ L 96/309, 29.3.2014, of the European Parliament and of the Council of 26 February 2014 on the harmonisation of the laws of the Member States relating to equipment and protective systems intended for use in potentially explosive atmospheres.

Conformance with the regulations laid down in these Directives is proven by fully complying with the following standards:

- DIN EN 1127-1: 2011
- DIN EN 80079-37: 2016
- DIN EN 60079-0: 2014
- DIN EN 80079-36: 2016
- DIN EN 80079-34: 2012
- DIN EN 15198: 2007

Type of explosion protection for equipment group II of categories 2 and 3:

-  II 2G Ex h IIB T4 Gb
-  II 2G Ex h IIC T4 Gb
-  II 2D Ex h IIIB T120° C Db
-  II 2D Ex h IIIC T120° C Db
-  II 3G Ex h IIB T4 Gc
-  II 3G Ex h IIC T4 Gc
-  II 3D Ex h IIIB T120° C Dc
-  II 3D Ex h IIIC T120° C Dc

The specific marking of the gearbox is noted on the rating plate.

The technical documentation for Category 2 gearboxes has been subjected to a voluntary validation. The documentation has been filed with the designated body under No. 0123, TÜV SÜD PRODUCT SERVICE GmbH, Ridlerstraße 65, 80339 München, Germany.

Tübingen, January 22, 2018

Georg Böing
Head of Research & Development

Florian Hanisch
Vice President Lead Factory Simogear

12.3 EC/EU Declaration of Conformity

Document No. A5E37802261AC

Manufacturer:	Siemens AG Division Digital Factory DF MC
Address:	Bahnhofstraße 40, 72072 Tübingen, Germany
Product designation:	Low-voltage motors, types
Sizes:	LA/LAI 63 - 80
Where relevant in conjunction with MOTOX gearbox types:	S

The designated product complies with the regulations of the following European Directive:

Directive 2014/35/EU, OJ L 96/357, 29.3.2014, of the European Parliament and of the Council of 26 February 2014 on the harmonisation of the laws of the Member States relating to the making available on the market of electrical equipment designed for use within certain voltage limits (Low-Voltage Directive).

Conformance with the regulations laid down in these Directives is proven by fully complying with the following standards:

- EN 60034-1: 2010 • EN 60034 - all other relevant sections in the latest version in each case
- EN 60664-1: 2007 • EN 60204-1: 2006 +A1: 2009 +AC: 2010

EC/EU Declarations of Conformity and / or manufacturer's declarations for all subassemblies, integrated and add-on units are available.

Specifically, these are:

- Electromagnetic brakes L, ZL, P, FDX, FDW, KFB with connected accessories such as rectifiers and switching devices
- External fan units F
- Shaft encoders IA, IM, IN, RE, TA

The designated product also complies with the regulations of the following legal acts:

- Commission Regulation (EC) No 640/2009 of 22 July 2009 implementing Directive 2005/32/EC of the European Parliament and of the Council with regard to ecodesign requirements for electric motors.
- Directive 2009/125/EC of the European Parliament and of the Council of 21 October 2009 establishing a framework for the setting of ecodesign requirements for energy-related products.
- Commission Regulation (EU) No 4/2014 of 6 January 2014 amending Regulation (EC) No 640/2009 implementing Directive 2005/32/EC of the European Parliament and of the Council with regard to ecodesign requirements for electric motors.

12.3 EC/EU Declaration of Conformity

Conformance with the regulations laid down in this legislation is proven by fully complying with EN 60034-30: 2009.

The designated product is intended for installation in a machine. Commissioning is prohibited until it has been established that the end product conforms with Directive 2006/42/EC.

First time that the CE marking was applied: 1995

Tübingen, April 24, 2018

Georg Böing
Head of Research & Development

Florian Hanisch
Vice President Lead Factory Simogear

This declaration certifies compliance with the Directives named above, but does not guarantee any specific properties or durability in the sense of § 443 BGB (Section of the German Civil Code governing guarantee provisions). Please observe the safety information in the supplied product documentation.

Further information

MOTOX on the Internet:

www.siemens.com/gearedmotors

Siemens AG
Division Digital Factory
Motion Control
Postfach 48 48
90026 NÜRNBERG
GERMANY