

## Avalanche Energy Rated N-Channel Power MOSFETs

12A and 14A, 60V-100V  
 $r_{DS(on)} = 0.18\Omega$  and  $0.25\Omega$

### Features:

- Single pulse avalanche energy rated
- SOA is power-dissipation limited
- Nanosecond switching speeds
- Linear transfer characteristics
- High input impedance

### N-CHANNEL ENHANCEMENT MODE

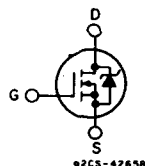

92CS-42658

TERMINAL DIAGRAM

### TERMINAL DESIGNATION

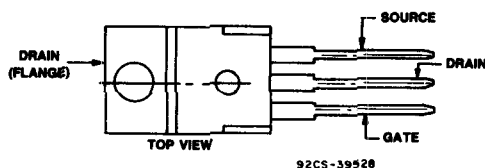

92CS-39528

JEDEC TO-220AB

The IRF530R, IRF531R, IRF532R and IRF533R are advanced power MOSFETs designed, tested, and guaranteed to withstand a specified level of energy in the breakdown avalanche mode of operation. These are n-channel enhancement-mode silicon-gate power field-effect transistors designed for applications such as switching regulators, switching converters, motor drivers, relay drivers, and drivers for high-power bipolar switching transistors requiring high speed and low gate-drive power. These types can be operated directly from integrated circuits.

The IRF-types are supplied in the JEDEC TO-220AB plastic package.

### Absolute Maximum Ratings

Parameter	IRF530R	IRF531R	IRF532R	IRF533R	Units
$V_{DS}$	100	60	100	60	V
$V_{DGR}$	100	60	100	60	V
$I_D @ T_c = 25^\circ\text{C}$	14	14	12	12	A
$I_D @ T_c = 100^\circ\text{C}$	9.0	9.0	8.0	8.0	A
$I_{DM}$	56	56	48	48	A
$V_{GS}$	±20				V
$P_D @ T_c = 25^\circ\text{C}$	75 (See Fig. 14)				W
	0.6 (See Fig. 14)				W/°C
$E_{AS}$	69				mj
$T_J$	-55 to 150				°C
$T_{stg}$	300 (0.063 in. (1.6mm) from case for 10s)				°C

IRF530R, IRF531R, IRF532R, IRF533R

Electrical Characteristics @ T<sub>C</sub> = 25°C (Unless Otherwise Specified)

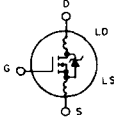
Parameter	Type	Min.	Typ.	Max.	Units	Test Conditions	
BV <sub>DSS</sub> Drain - Source Breakdown Voltage	IRF530R IRF532R	100	—	—	V	V <sub>GS</sub> = 0V	
	IRF531R IRF533R	60	—	—	V	I <sub>D</sub> = 250μA	
V <sub>GS(th)</sub> Gate Threshold Voltage	ALL	2.0	—	4.0	V	V <sub>DS</sub> = V <sub>GS</sub> , I <sub>D</sub> = 250μA	
I <sub>loss</sub> Gate-Source Leakage Forward	ALL	—	—	500	nA	V <sub>GS</sub> = 20V	
I <sub>loss</sub> Gate-Source Leakage Reverse	ALL	—	—	-500	nA	V <sub>GS</sub> = -20V	
I <sub>oss</sub> Zero Gate Voltage Drain Current	ALL	—	—	250	μA	V <sub>DS</sub> = Max. Rating, V <sub>GS</sub> = 0V	
		—	—	1000	μA	V <sub>DS</sub> = Max. Rating x 0.8, V <sub>GS</sub> = 0V, T <sub>C</sub> = 125°C	
I <sub>D(on)</sub> On-State Drain Current ②	IRF530R IRF531R	14	—	—	A	V <sub>DS</sub> > I <sub>D(on)</sub> x R <sub>D(Son)</sub> max., V <sub>GS</sub> = 10V	
	IRF532R IRF533R	12	—	—	A		
R <sub>D(Son)</sub> Static Drain-Source On-State Resistance ②	IRF530R IRF531R	—	0.14	0.18	Ω	V <sub>GS</sub> = 10V, I <sub>D</sub> = 8.0A	
	IRF532R IRF533R	—	0.20	0.25	Ω		
g <sub>fs</sub> Forward Transconductance ②	ALL	4.0	5.5	—	S (Ω)	V <sub>DS</sub> > I <sub>D(on)</sub> x R <sub>D(Son)</sub> max., I <sub>D</sub> = 8.0A	
C <sub>iss</sub> Input Capacitance	ALL	—	600	—	pF	V <sub>GS</sub> = 0V, V <sub>DS</sub> = 25V, f = 1.0 MHz	
C <sub>oss</sub> Output Capacitance	ALL	—	300	—	pF	See Fig. 10	
C <sub>rss</sub> Reverse Transfer Capacitance	ALL	—	100	—	pF		
t <sub>D(on)</sub> Turn-On Delay Time	ALL	—	—	30	ns	V <sub>DD</sub> = 36V, I <sub>D</sub> = 8.0A, Z <sub>o</sub> = 15Ω	
t <sub>r</sub> Rise Time	ALL	—	—	75	ns	See Fig. 17	
t <sub>D(off)</sub> Turn-Off Delay Time	ALL	—	—	40	ns	(MOSFET switching times are essentially independent of operating temperature.)	
t <sub>f</sub> Fall Time	ALL	—	—	45	ns		
Q <sub>g</sub> Total Gate Charge (Gate-Source Plus Gate-Drain)	ALL	—	18	30	nC	V <sub>GS</sub> = 10V, I <sub>D</sub> = 18A, V <sub>DS</sub> = 0.8 Max. Rating. See Fig. 18 for test circuit. (Gate charge is essentially independent of operating temperature.)	
Q <sub>gs</sub> Gate-Source Charge	ALL	—	9.0	—	nC		
Q <sub>gd</sub> Gate-Drain ("Miller") Charge	ALL	—	9.0	—	nC		
L <sub>D</sub> Internal Drain Inductance	ALL	—	3.5	—	nH	Measured from the contact screw on tab to center of die.	Modified MOSFET symbol showing the internal device inductances. 
		—	4.5	—	nH		
L <sub>S</sub> Internal Source Inductance	ALL	—	7.5	—	nH	Measured from the source lead, 6mm (0.25 in.) from package to source bonding pad.	

Thermal Resistance

R <sub>thJC</sub> Junction-to-Case	ALL	—	—	1.67	°C/W	
R <sub>thCS</sub> Case-to-Sink	ALL	—	1.0	—	°C/W	Mounting surface flat, smooth, and greased.
R <sub>thJA</sub> Junction-to-Ambient	ALL	—	—	80	°C/W	Free Air Operation

Source-Drain Diode Ratings and Characteristics

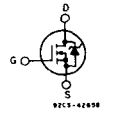
I <sub>S</sub> Continuous Source Current (Body Diode)	IRF530R IRF531R	—	—	14	A	Modified MOSFET symbol showing the integral reverse P-N junction rectifier. 
	IRF532R IRF533R	—	—	12	A	
I <sub>SM</sub> Pulse Source Current (Body Diode) ③	IRF530R IRF531R	—	—	56	A	
	IRF532R IRF533R	—	—	48	A	
V <sub>SD</sub> Diode Forward Voltage ②	IRF530R IRF531R	—	—	2.5	V	T <sub>C</sub> = 25°C, I <sub>S</sub> = 14A, V <sub>GS</sub> = 0V
	IRF532R IRF533R	—	—	2.3	V	T <sub>C</sub> = 25°C, I <sub>S</sub> = 12A, V <sub>GS</sub> = 0V
t <sub>rr</sub> Reverse Recovery Time	ALL	—	360	—	ns	T <sub>J</sub> = 150°C, I <sub>F</sub> = 14A, di/dt = 100A/μs
Q <sub>RR</sub> Reverse Recovered Charge	ALL	—	2.1	—	μC	T <sub>J</sub> = 150°C, I <sub>F</sub> = 14A, di/dt = 100A/μs
t <sub>on</sub> Forward Turn-on Time	ALL	Intrinsic turn-on time is negligible. Turn-on speed is substantially controlled by L <sub>S</sub> + L <sub>D</sub> .				

① T<sub>J</sub> = 25°C to 150°C.

② Pulse Test: Pulse width ≤ 300μs, Duty Cycle ≤ 2%.

③ Repetitive Rating: Pulse width limited by max. junction temperature. See Transient Thermal Impedance Curve (Fig. 5).

④ V<sub>DD</sub> = 25V, starting T<sub>J</sub> = 25°C, L = 530μH, R<sub>GS</sub> = 25Ω, I<sub>peak</sub> = 14A. See figures 15, 16.

IRF530R, IRF531R, IRF532R, IRF533R

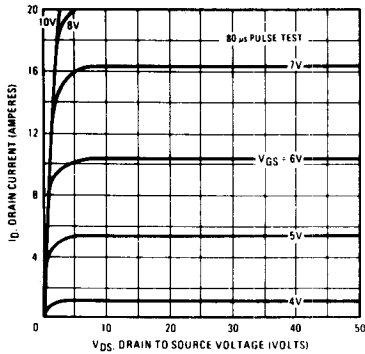

Fig. 1 - Typical Output Characteristics

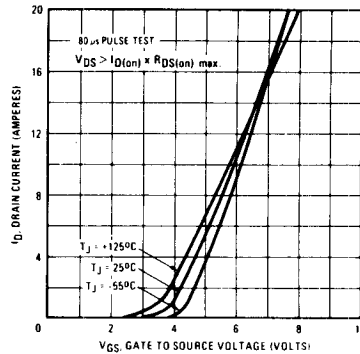

Fig. 2 - Typical Transfer Characteristics

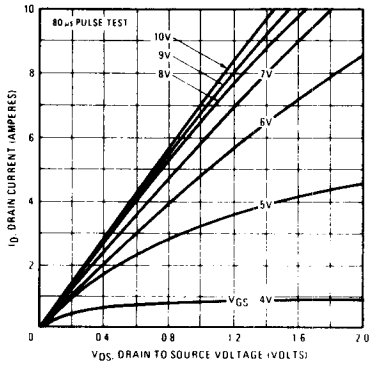

Fig. 3 - Typical Saturation Characteristics

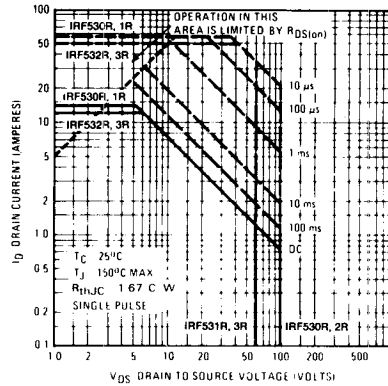

Fig. 4 - Maximum Safe Operating Area

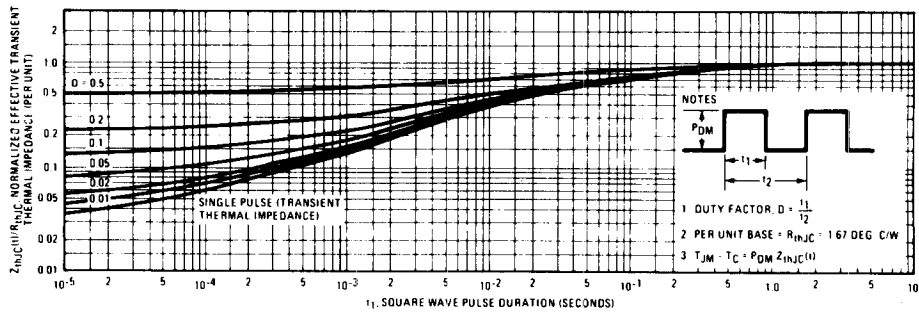

Fig. 5 - Maximum Effective Transient Thermal Impedance, Junction-to-Case Vs. Pulse Duration

6

IRF530R, IRF531R, IRF532R, IRF533R

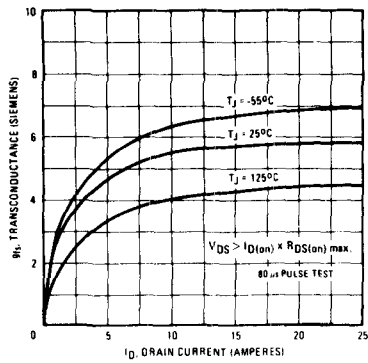

Fig. 6 – Typical Transconductance Vs. Drain Current

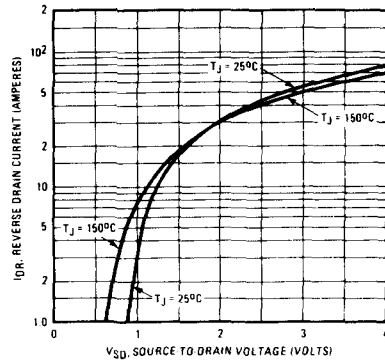

Fig. 7 – Typical Source-Drain Diode Forward Voltage

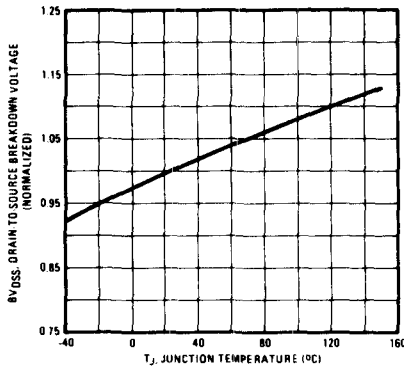

Fig. 8 – Breakdown Voltage Vs. Temperature

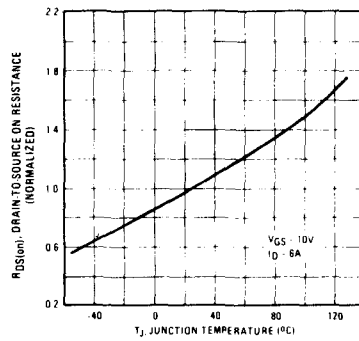

Fig. 9 – Normalized On-Resistance Vs. Temperature

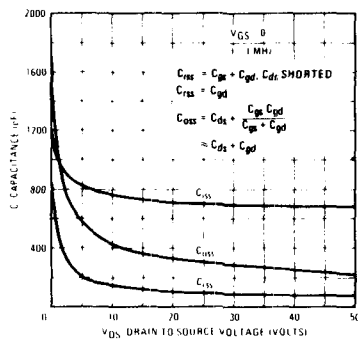

Fig. 10 – Typical Capacitance Vs. Drain-to-Source Voltage

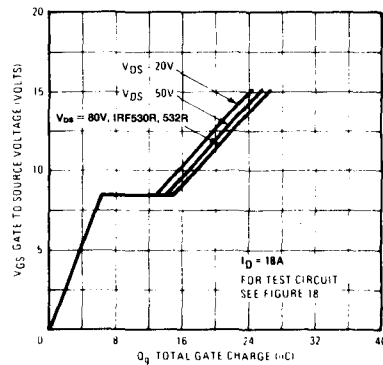

Fig. 11 – Typical Gate Charge Vs. Gate-to-Source Voltage

IRF530R, IRF531R, IRF532R, IRF533R

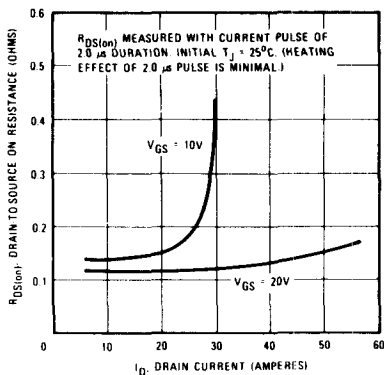

Fig. 12 – Typical On-Resistance Vs. Drain Current

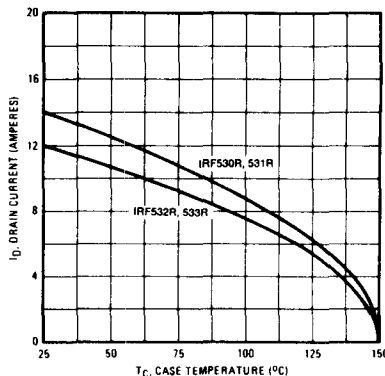

Fig. 13 – Maximum Drain Current Vs. Case Temperature

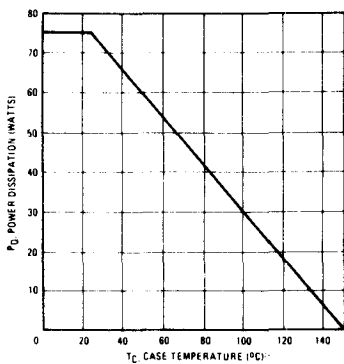

Fig. 14 – Power Vs. Temperature Derating Curve

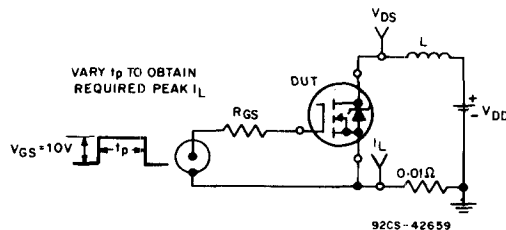

Fig. 15 – Unclamped Energy Test Circuit

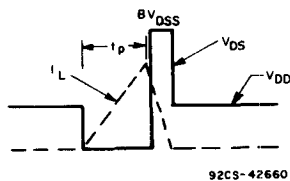

Fig. 16 – Unclamped Energy Waveforms

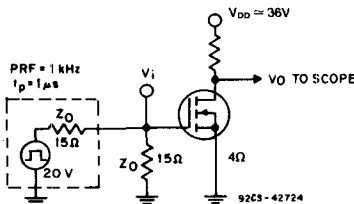

Fig. 17 – Switching Time Test Circuit

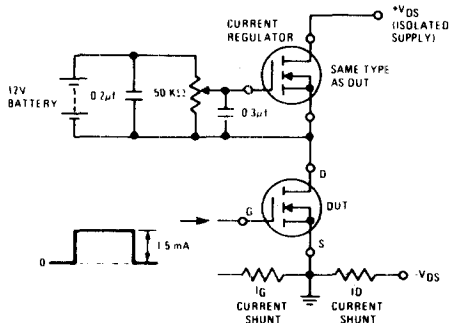

Fig. 18 – Gate Charge Test Circuit