

LM2574/LM2574HV SIMPLE SWITCHER™ 0.5A Step-Down Voltage Regulator

General Description

The LM2574 series of regulators are monolithic integrated circuits that provide all the active functions for a step-down (buck) switching regulator, capable of driving a 0.5A load with excellent line and load regulation. These devices are available in fixed output voltages of 3.3V, 5V, 12V, 15V, and an adjustable output version.

Requiring a minimum number of external components, these regulators are simple to use and include internal frequency compensation and a fixed-frequency oscillator.

The LM2574 series offers a high-efficiency replacement for popular three-terminal linear regulators. Because of its high efficiency, the copper traces on the printed circuit board are normally the only heat sinking needed.

A standard series of inductors optimized for use with the LM2574 are available from several different manufacturers. This feature greatly simplifies the design of switch-mode power supplies.

Other features include a guaranteed $\pm 4\%$ tolerance on output voltage within specified input voltages and output load conditions, and $\pm 10\%$ on the oscillator frequency. External shutdown is included, featuring 50 μA (typical) standby current. The output switch includes cycle-by-cycle current limiting, as well as thermal shutdown for full protection under fault conditions.

Features

- 3.3V, 5V, 12V, 15V, and adjustable output versions
- Adjustable version output voltage range, 1.23V to 37V (57V for HV version) $\pm 4\%$ max over line and load conditions
- Guaranteed 0.5A output current
- Wide input voltage range, 40V, up to 60V for HV version
- Requires only 4 external components
- 52 kHz fixed frequency internal oscillator
- TTL shutdown capability, low power standby mode
- High efficiency
- Uses readily available standard inductors
- Thermal shutdown and current limit protection

Applications

- Simple high-efficiency step-down (buck) regulator
- Efficient pre-regulator for linear regulators
- On-card switching regulators
- Positive to negative converter (Buck-Boost)

Typical Application (Fixed Output Voltage Versions)

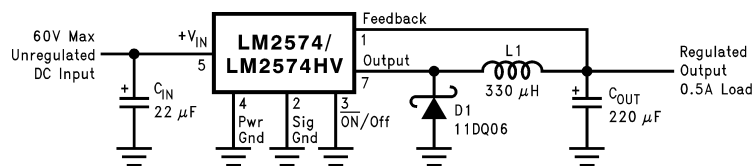

DS011394-1

Note: Pin numbers are for 8-pin DIP package.

Connection Diagrams

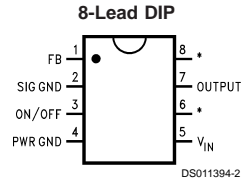

* No internal connection, but should be soldered to PC board for best heat transfer.

Top View
Order Number LM2574-3.3HVN, LM2574HVN-5.0,
LM2574HVN-12, LM2574HVN-15, LM2574HVN-ADJ,
LM2574N-3.3, LM2574N-5.0, LM2574N-12,
LM2574N-15 or LM2574N-ADJ
See NS Package Number N08A

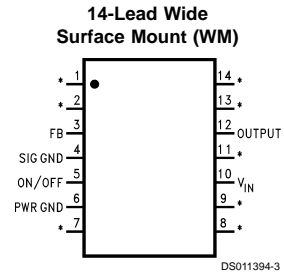

Top View
Order Number LM2574HVM-3.3, LM2574HVM-5.0,
LM2574HVM-12, LM2574HVM-15, LM2574HVM-ADJ,
LM2574M-3.3 LM2574M-5.0, LM2574M-12,
LM2574M-15 or LM2574M-ADJ
See NS Package Number M14B

Absolute Maximum Ratings (Note 1)

If Military/Aerospace specified devices are required, please contact the National Semiconductor Sales Office/Distributors for availability and specifications.

Maximum Supply Voltage	
LM2574	45V
LM2574HV	63V
$\overline{\text{ON}}$ /OFF Pin Input Voltage	$-0.3\text{V} \leq V \leq +V_{\text{IN}}$
Output Voltage to Ground (Steady State)	-1V
Minimum ESD Rating (C = 100 pF, R = 1.5 k Ω)	2 kV
Storage Temperature Range	-65°C to +150°C

Lead Temperature (Soldering, 10 seconds)	260°C
Maximum Junction Temperature	150°C
Power Dissipation	Internally Limited

Operating Ratings

Temperature Range	LM2574/LM2574HV	-40°C \leq T _J \leq +125°C
Supply Voltage	LM2574	40V
	LM2574HV	60V

LM2574-3.3, LM2574HV-3.3 Electrical Characteristics

Specifications with standard type face are for T_J = 25°C, and those with **boldface type** apply over full Operating Temperature Range.

Symbol	Parameter	Conditions	LM2574-3.3 LM2574HV-3.3		Units (Limits)
			Typ	Limit (Note 2)	
SYSTEM PARAMETERS (Note 3) Test Circuit <i>Figure 2</i>					
V _{OUT}	Output Voltage	V _{IN} = 12V, I _{LOAD} = 100 mA	3.3	3.234 3.366	V V(Min) V(Max)
V _{OUT}	Output Voltage LM2574	4.75V \leq V _{IN} \leq 40V, 0.1A \leq I _{LOAD} \leq 0.5A	3.3	3.168/ 3.135 3.432/ 3.465	V V(Min) V(Max)
V _{OUT}	Output Voltage LM2574HV	4.75V \leq V _{IN} \leq 60V, 0.1A \leq I _{LOAD} \leq 0.5A	3.3	3.168/ 3.135 3.450/ 3.482	V(Min) V(Max)
η	Efficiency	V _{IN} = 12V, I _{LOAD} = 0.5A	72		%

LM2574-5.0, LM2574HV-5.0 Electrical Characteristics

Specifications with standard type face are for T_J = 25°C, and those with **boldface type** apply over full Operating Temperature Range.

Symbol	Parameter	Conditions	LM2574-5.0 LM2574HV-5.0		Units (Limits)
			Typ	Limit (Note 2)	
SYSTEM PARAMETERS (Note 3) Test Circuit <i>Figure 2</i>					
V _{OUT}	Output Voltage	V _{IN} = 12V, I _{LOAD} = 100 mA	5	4.900 5.100	V V(Min) V(Max)
V _{OUT}	Output Voltage LM2574	7V \leq V _{IN} \leq 40V, 0.1A \leq I _{LOAD} \leq 0.5A	5	4.800/ 4.750 5.200/ 5.250	V V(Min) V(Max)
V _{OUT}	Output Voltage LM2574HV	7V \leq V _{IN} \leq 60V, 0.1A \leq I _{LOAD} \leq 0.5A	5	4.800/ 4.750 5.225/ 5.275	V(Min) V(Max)
η	Efficiency	V _{IN} = 12V, I _{LOAD} = 0.5A	77		%

LM2574-12, LM2574HV-12 Electrical Characteristics

Specifications with standard type face are for $T_J = 25^\circ\text{C}$, and those with **boldface type** apply over **full Operating Temperature Range**.

Symbol	Parameter	Conditions	LM2574-12 LM2574HV-12		Units (Limits)
			Typ	Limit (Note 2)	
SYSTEM PARAMETERS (Note 3) Test Circuit <i>Figure 2</i>					
V_{OUT}	Output Voltage	$V_{IN} = 25\text{V}$, $I_{LOAD} = 100\text{ mA}$	12	11.76 12.24	V V(Min) V(Max)
V_{OUT}	Output Voltage LM2574	$15\text{V} \leq V_{IN} \leq 40\text{V}$, $0.1\text{A} \leq I_{LOAD} \leq 0.5\text{A}$	12	11.52/ 11.40 12.48/ 12.60	V V(Min) V(Max)
V_{OUT}	Output Voltage LM2574HV	$15\text{V} \leq V_{IN} \leq 60\text{V}$, $0.1\text{A} \leq I_{LOAD} \leq 0.5\text{A}$	12	11.52/ 11.40 12.54/ 12.66	V(Min) V(Max)
η	Efficiency	$V_{IN} = 15\text{V}$, $I_{LOAD} = 0.5\text{A}$	88		%

LM2574-15, LM2574HV-15 Electrical Characteristics

Specifications with standard type face are for $T_J = 25^\circ\text{C}$, and those with **boldface type** apply over **full Operating Temperature Range**.

Symbol	Parameter	Conditions	LM2574-15 LM2574HV-15		Units (Limits)
			Typ	Limit (Note 2)	
SYSTEM PARAMETERS (Note 3) Test Circuit <i>Figure 2</i>					
V_{OUT}	Output Voltage	$V_{IN} = 30\text{V}$, $I_{LOAD} = 100\text{ mA}$	15	14.70 15.30	V V(Min) V(Max)
V_{OUT}	Output Voltage LM2574	$18\text{V} \leq V_{IN} \leq 40\text{V}$, $0.1\text{A} \leq I_{LOAD} \leq 0.5\text{A}$	15	14.40/ 14.25 15.60/ 15.75	V V(Min) V(Max)
V_{OUT}	Output Voltage LM2574HV	$18\text{V} \leq V_{IN} \leq 60\text{V}$, $0.1\text{A} \leq I_{LOAD} \leq 0.5\text{A}$	15	14.40/ 14.25 15.68/ 15.83	V(Min) V(Max)
η	Efficiency	$V_{IN} = 18\text{V}$, $I_{LOAD} = 0.5\text{A}$	88		%

LM2574-ADJ, LM2574HV-ADJ Electrical Characteristics

Specifications with standard type face are for $T_J = 25^\circ\text{C}$, and those with **boldface type** apply over **full Operating Temperature Range**. Unless otherwise specified, $V_{IN} = 12\text{V}$, $I_{LOAD} = 100\text{ mA}$.

Symbol	Parameter	Conditions	LM2574-ADJ LM2574HV-ADJ		Units (Limits)
			Typ	Limit (Note 2)	
SYSTEM PARAMETERS (Note 3) Test Circuit <i>Figure 2</i>					
V_{FB}	Feedback Voltage	$V_{IN} = 12\text{V}$, $I_{LOAD} = 100\text{ mA}$	1.230	1.217 1.243	V V(Min) V(Max)

LM2574-ADJ, LM2574HV-ADJ

Electrical Characteristics (Continued)

Specifications with standard type face are for $T_J = 25^\circ\text{C}$, and those with **boldface type** apply over **full Operating Temperature Range**. Unless otherwise specified, $V_{IN} = 12\text{V}$, $I_{LOAD} = 100\text{ mA}$.

Symbol	Parameter	Conditions	LM2574-ADJ LM2574HV-ADJ		Units (Limits)
			Typ	Limit (Note 2)	
SYSTEM PARAMETERS (Note 3) Test Circuit <i>Figure 2</i>					
V_{FB}	Feedback Voltage LM2574	$7\text{V} \leq V_{IN} \leq 40\text{V}$, $0.1\text{A} \leq I_{LOAD} \leq 0.5\text{A}$ V_{OUT} Programmed for 5V. Circuit of <i>Figure 2</i>	1.230	1.193/ 1.180 1.267/ 1.280	V V(Min) V(Max)
V_{FB}	Feedback Voltage LM2574HV	$7\text{V} \leq V_{IN} \leq 60\text{V}$, $0.1\text{A} \leq I_{LOAD} \leq 0.5\text{A}$ V_{OUT} Programmed for 5V. Circuit of <i>Figure 2</i>	1.230	1.193/ 1.180 1.273/ 1.286	V(Min) V(Max)
η	Efficiency	$V_{IN} = 12\text{V}$, $V_{OUT} = 5\text{V}$, $I_{LOAD} = 0.5\text{A}$	77		%

All Output Voltage Versions Electrical Characteristics

Specifications with standard type face are for $T_J = 25^\circ\text{C}$, and those with **boldface type** apply over **full Operating Temperature Range**. Unless otherwise specified, $V_{IN} = 12\text{V}$ for the 3.3V, 5V, and Adjustable version, $V_{IN} = 25\text{V}$ for the 12V version, and $V_{IN} = 30\text{V}$ for the 15V version. $I_{LOAD} = 100\text{ mA}$.

Symbol	Parameter	Conditions	LM2574-XX LM2574HV-XX		Units (Limits)
			Typ	Limit (Note 2)	
DEVICE PARAMETERS					
I_b	Feedback Bias Current	Adjustable Version Only, $V_{OUT} = 5\text{V}$	50	100/ 500	nA
f_O	Oscillator Frequency	(see Note 10)	52	47/ 42 58/ 63	kHz kHz(Min) kHz(Max)
V_{SAT}	Saturation Voltage	$I_{OUT} = 0.5\text{A}$ (Note 4)	0.9	1.2/ 1.4	V V(max)
DC	Max Duty Cycle (ON)	(Note 5)	98	93	% %(Min)
I_{CL}	Current Limit	Peak Current, (Notes 4, 10)	1.0	0.7/ 0.65 1.6/ 1.8	A A(Min) A(Max)
I_L	Output Leakage Current	(Notes 6, 7) Output = 0V Output = -1V Output = -1V	7.5	2 30	mA(Max) mA mA(Max)
I_Q	Quiescent Current	(Note 6)	5	10	mA mA(Max)
I_{STBY}	Standby Quiescent Current	$\overline{\text{ON}} / \text{OFF}$ Pin = 5V (OFF)	50	200	μA $\mu\text{A}(\text{Max})$
θ_{JA}	Thermal Resistance	N Package, Junction to Ambient (Note 8)	92		$^\circ\text{C/W}$
θ_{JA}		N Package, Junction to Ambient (Note 9)	72		
θ_{JA}		M Package, Junction to Ambient (Note 8)	102		
θ_{JA}		M Package, Junction to Ambient (Note 9)	78		

All Output Voltage Versions Electrical Characteristics (Continued)

Specifications with standard type face are for $T_J = 25^\circ\text{C}$, and those with **boldface type** apply over **full Operating Temperature Range**. Unless otherwise specified, $V_{IN} = 12\text{V}$ for the 3.3V, 5V, and Adjustable version, $V_{IN} = 25\text{V}$ for the 12V version, and $V_{IN} = 30\text{V}$ for the 15V version. $I_{LOAD} = 100\text{mA}$.

Symbol	Parameter	Conditions	LM2574-XX LM2574HV-XX		Units (Limits)
			Typ	Limit (Note 2)	
ON /OFF CONTROL Test Circuit <i>Figure 2</i>					
V_{IH}	$\overline{\text{ON}}$ /OFF Pin Logic	$V_{OUT} = 0\text{V}$	1.4	2.2/2.4	V(Min)
V_{IL}	Input Level	$V_{OUT} = \text{Nominal Output Voltage}$	1.2	1.0/0.8	V(Max)
I_H	$\overline{\text{ON}}$ /OFF Pin Input Current	$\overline{\text{ON}}$ /OFF Pin = 5V (OFF)	12	30	μA $\mu\text{A}(\text{Max})$
I_{IL}		$\overline{\text{ON}}$ /OFF Pin = 0V (ON)	0	10	μA $\mu\text{A}(\text{Max})$

Note 1: Absolute Maximum Ratings indicate limits beyond which damage to the device may occur. Operating Ratings indicate conditions for which the device is intended to be functional, but do not guarantee specific performance limits. For guaranteed specifications and test conditions, see the Electrical Characteristics.

Note 2: All limits guaranteed at room temperature (Standard type face) and at temperature extremes (bold type face). All room temperature limits are 100% production tested. All limits at temperature extremes are guaranteed via correlation using standard Statistical Quality Control (SQC) methods. All limits are used to calculate Average Outgoing Quality Level.

Note 3: External components such as the catch diode, inductor, input and output capacitors can affect switching regulator system performance. When the LM2574 is used as shown in the *Figure 2* test circuit, system performance will be as shown in system parameters section of Electrical Characteristics.

Note 4: Output pin sourcing current. No diode, inductor or capacitor connected to output pin.

Note 5: Feedback pin removed from output and connected to 0V.

Note 6: Feedback pin removed from output and connected to +12V for the Adjustable, 3.3V, and 5V versions, and +25V for the 12V and 15V versions, to force the output transistor OFF.

Note 7: $V_{IN} = 40\text{V}$ (60V for high voltage version).

Note 8: Junction to ambient thermal resistance with approximately 1 square inch of printed circuit board copper surrounding the leads. Additional copper area will lower thermal resistance further. See application hints in this data sheet and the thermal model in Switchers Made Simple software.

Note 9: Junction to ambient thermal resistance with approximately 4 square inches of 1 oz. (0.0014 in. thick) printed circuit board copper surrounding the leads. Additional copper area will lower thermal resistance further. (See Note 8.)

Note 10: The oscillator frequency reduces to approximately 18 kHz in the event of an output short or an overload which causes the regulated output voltage to drop approximately 40% from the nominal output voltage. This self protection feature lowers the average power dissipation of the IC by lowering the minimum duty cycle from 5% down to approximately 2%.

Typical Performance Characteristics (Circuit of *Figure 2*)

Normalized Output Voltage

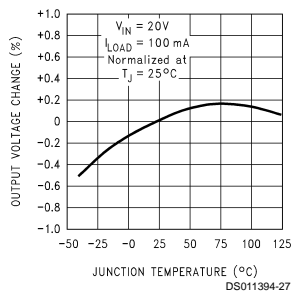

Line Regulation

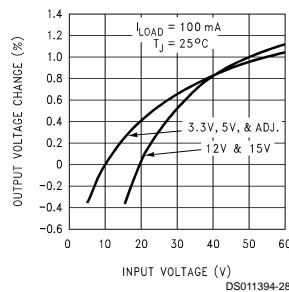

Dropout Voltage

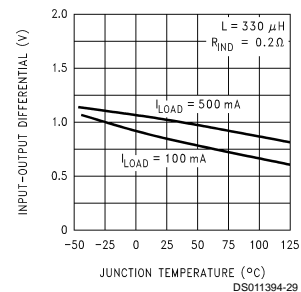

Typical Performance Characteristics (Circuit of Figure 2) (Continued)

Current Limit

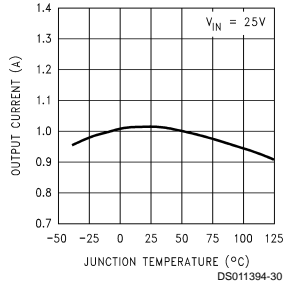

Supply Current

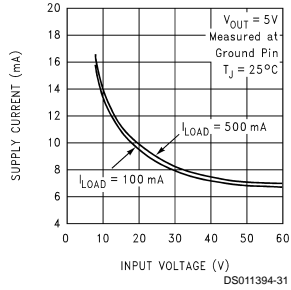

Standby Quiescent Current

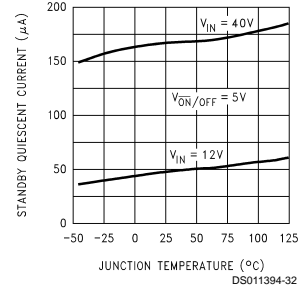

Oscillator Frequency

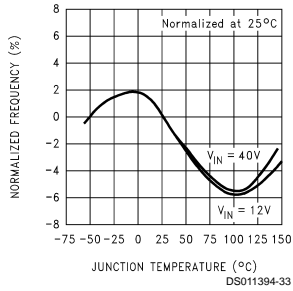

Switch Saturation Voltage

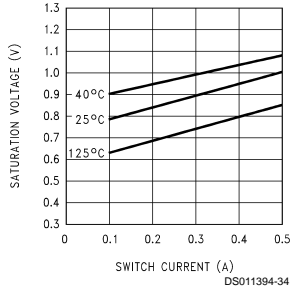

Efficiency

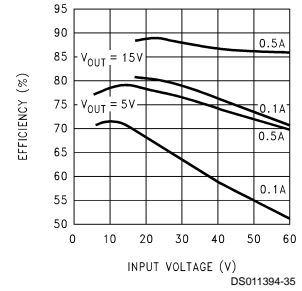

Minimum Operating Voltage

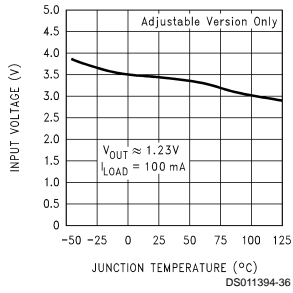

Supply Current vs Duty Cycle

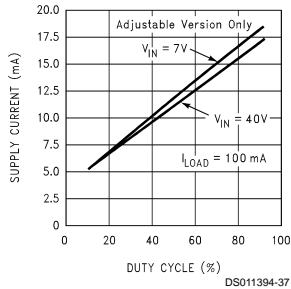

Feedback Voltage vs Duty Cycle

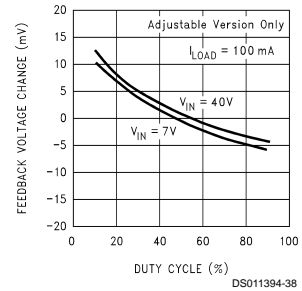

Typical Performance Characteristics (Circuit of Figure 2) (Continued)

Feedback Pin Current

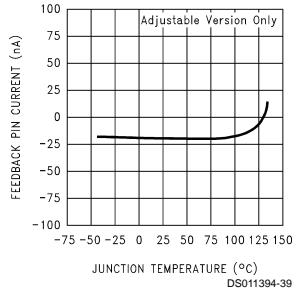

Junction to Ambient Thermal Resistance

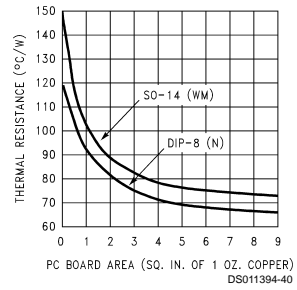

Continuous Mode Switching Waveforms $V_{OUT} = 5V$, 500 mA Load Current, $L = 330 \mu H$

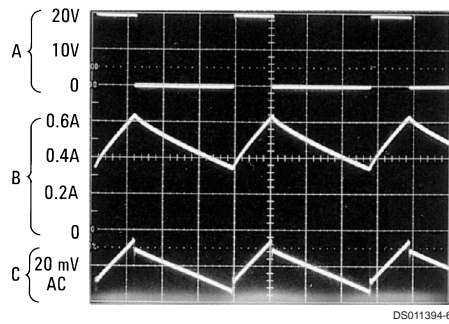

Notes:
A: Output Pin Voltage, 10V/div
B: Inductor Current, 0.2 A/div
C: Output Ripple Voltage, 20 mV/div,
AC-Coupled
Horizontal Time Base: 5 μs /div

Discontinuous Mode Switching Waveforms $V_{OUT} = 5V$, 100 mA Load Current, $L = 100 \mu H$

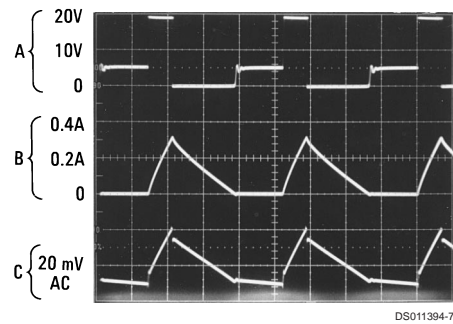

Notes:
A: Output Pin Voltage, 10V/div
B: Inductor Current, 0.2 A/div
C: Output Ripple Voltage, 20 mV/div,
AC-Coupled
Horizontal Time Base: 5 μs /div

500 mA Load Transient Response for Continuous Mode Operation. $L = 330 \mu H$, $C_{OUT} = 300 \mu F$

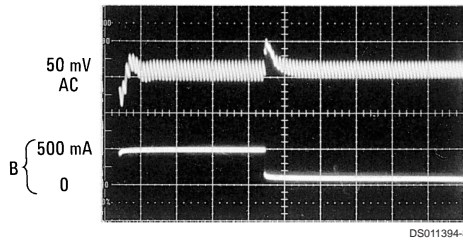

Notes:
A: Output Voltage, 50 mV/div.
AC Coupled
B: 100 mA to 500 mA Load Pulse
Horizontal Time Base: 200 μs /div

250 mA Load Transient Response for Discontinuous Mode Operation. $L = 68 \mu H$, $C_{OUT} = 470 \mu F$

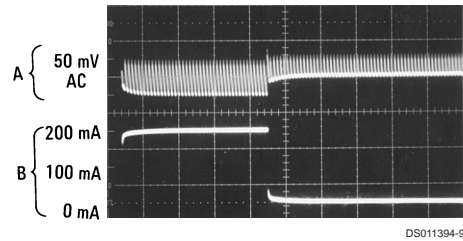

Notes:
A: Output Voltage, 50 mV/div.
AC Coupled
B: 50 mA to 250 mA Load Pulse
Horizontal Time Base: 200 μs /div

Block Diagram

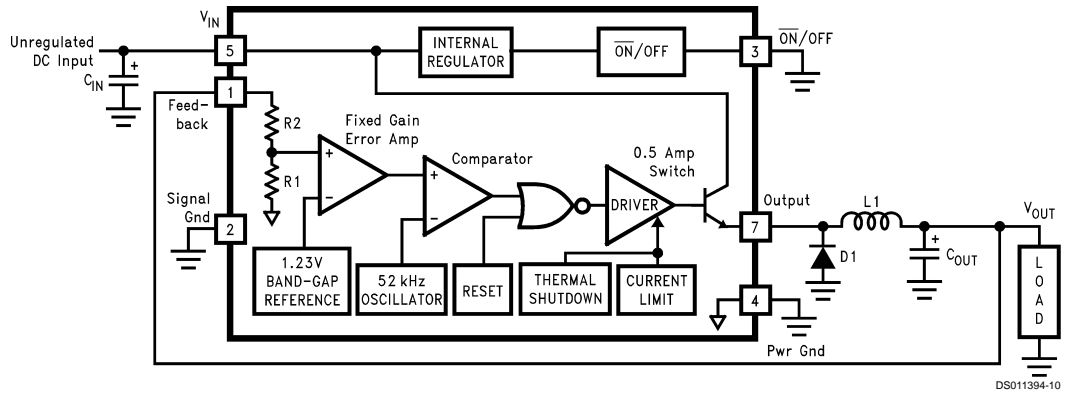

R1 = 1k
 3.3V, R2 = 1.7k
 5V, R2 = 3.1k
 12V, R2 = 8.84k
 15V, R2 = 11.3k
 For Adj. Version
 R1 = Open, R2 = 0Ω

Note: Pin numbers are for the 8-pin DIP package.

FIGURE 1.

Test Circuit and Layout Guidelines

Fixed Output Voltage Versions

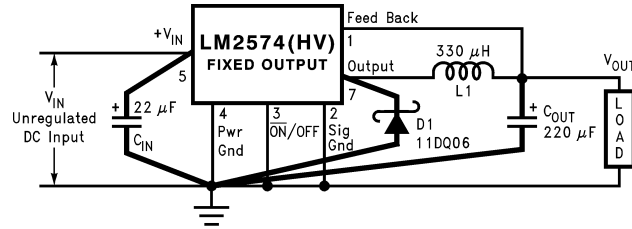

DS011394-11

- C_{IN} — 22 μF, 75V
Aluminum Electrolytic
- C_{OUT} — 220 μF, 25V
Aluminum Electrolytic
- D1 — Schottky, 11DQ06
- L1 — 330 μH, 52627
(for 5V in, 3.3V out, use
100 μH, RL-1284-100)
- R1 — 2k, 0.1%
- R2 — 6.12k, 0.1%

Adjustable Output Voltage Version

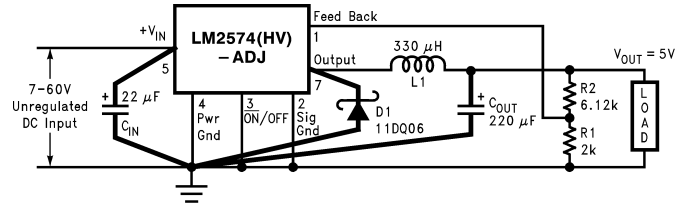

DS011394-12

$$V_{OUT} = V_{REF} \left(1 + \frac{R_2}{R_1} \right)$$

$$R_2 = R_1 \left(\frac{V_{OUT}}{V_{REF}} - 1 \right)$$

where $V_{REF} = 1.23V$,
R1 between 1k & 5k.

FIGURE 2.

As in any switching regulator, layout is very important. Rapidly switching currents associated with wiring inductance generate voltage transients which can cause problems. For minimal inductance and ground loops, the length of the leads indicated by **heavy lines should be kept as short as possible**. Single-point grounding (as indicated) or ground plane construction should be used for best results. When using the Adjustable version, physically locate the programming resistors near the regulator, to keep the sensitive feedback wiring short.

Test Circuit and Layout Guidelines

(Continued)

Inductor Value	Pulse Eng. (Note 1)	Renco (Note 2)	NPI (Note 3)
68 μ H	*	RL-1284-68-43	NP5915
100 μ H	*	RL-1284-100-43	NP5916
150 μ H	52625	RL-1284-150-43	NP5917
220 μ H	52626	RL-1284-220-43	NP5918/5919
330 μ H	52627	RL-1284-330-43	NP5920/5921
470 μ H	52628	RL-1284-470-43	NP5922
680 μ H	52629	RL-1283-680-43	NP5923
1000 μ H	52631	RL-1283-1000-43	*
1500 μ H	*	RL-1283-1500-43	*
2200 μ H	*	RL-1283-2200-43	*

FIGURE 3. Inductor Selection by Manufacturer's Part Number

U.S. Source

Note 1: Pulse Engineering, (619) 674-8100
P.O. Box 12236, San Diego, CA 92112

Note 2: Renco Electronics Inc., (516) 586-5566
60 Jeffryn Blvd. East, Deer Park, NY 11729

*Contact Manufacturer

European Source

Note 3: NPI/APC +44 (0) 634 290588

47 Riverside, Medway City Estate
Strood, Rochester, Kent ME2 4DP. UK

*Contact Manufacturer

LM2574 Series Buck Regulator Design Procedure

PROCEDURE (Fixed Output Voltage Versions)	EXAMPLE (Fixed Output Voltage Versions)
<p>Given: V_{OUT} = Regulated Output Voltage (3.3V, 5V, 12V, or 15V) $V_{IN(Max)}$ = Maximum Input Voltage $I_{LOAD(Max)}$ = Maximum Load Current</p> <p>1. Inductor Selection (L1) A. Select the correct Inductor value selection guide from <i>Figures 4, 5, 6, or Figure 7</i>. (Output voltages of 3.3V, 5V, 12V or 15V respectively). For other output voltages, see the design procedure for the adjustable version. B. From the inductor value selection guide, identify the inductance region intersected by $V_{IN(Max)}$ and $I_{LOAD(Max)}$. C. Select an appropriate inductor from the table shown in <i>Figure 3</i>. Part numbers are listed for three inductor manufacturers. The inductor chosen must be rated for operation at the LM2574 switching frequency (52 kHz) and for a current rating of $1.5 \times I_{LOAD}$. For additional inductor information, see the inductor section in the Application Hints section of this data sheet.</p> <p>2. Output Capacitor Selection (C_{OUT}) A. The value of the output capacitor together with the inductor defines the dominate pole-pair of the switching regulator loop. For stable operation and an acceptable output ripple voltage, (approximately 1% of the output voltage) a value between 100 μF and 470 μF is recommended. B. The capacitor's voltage rating should be at least 1.5 times greater than the output voltage. For a 5V regulator, a rating of at least 8V is appropriate, and a 10V or 15V rating is recommended. Higher voltage electrolytic capacitors generally have lower ESR numbers, and for this reason it may be necessary to select a capacitor rated for a higher voltage than would normally be needed.</p> <p>3. Catch Diode Selection (D1) A. The catch-diode current rating must be at least 1.5 times greater than the maximum load current. Also, if the power supply design must withstand a continuous output short, the diode should have a current rating equal to the maximum current limit of the LM2574. The most stressful condition for this diode is an overload or shorted output condition. B. The reverse voltage rating of the diode should be at least 1.25 times the maximum input voltage.</p> <p>4. Input Capacitor (C_{IN}) An aluminum or tantalum electrolytic bypass capacitor located close to the regulator is needed for stable operation.</p>	<p>Given: V_{OUT} = 5V $V_{IN(Max)}$ = 15V $I_{LOAD(Max)}$ = 0.4A</p> <p>1. Inductor Selection (L1) A. Use the selection guide shown in <i>Figure 5</i>. B. From the selection guide, the inductance area intersected by the 15V line and 0.4A line is 330. C. Inductor value required is 330 μH. From the table in <i>Figure 3</i>, choose Pulse Engineering PE-52627, Renco RL-1284-330, or NPI NP5920/5921.</p> <p>2. Output Capacitor Selection (C_{OUT}) A. C_{OUT} = 100 μF to 470 μF standard aluminum electrolytic. B. Capacitor voltage rating = 20V.</p> <p>3. Catch Diode Selection (D1) A. For this example, a 1A current rating is adequate. B. Use a 20V 1N5817 or SR102 Schottky diode, or any of the suggested fast-recovery diodes shown in <i>Figure 9</i>.</p> <p>4. Input Capacitor (C_{IN}) A 22 μF aluminum electrolytic capacitor located near the input and ground pins provides sufficient bypassing.</p>

LM2574 Series Buck Regulator Design Procedure (Continued)

INDUCTOR VALUE SELECTION GUIDES (For Continuous Mode Operation)

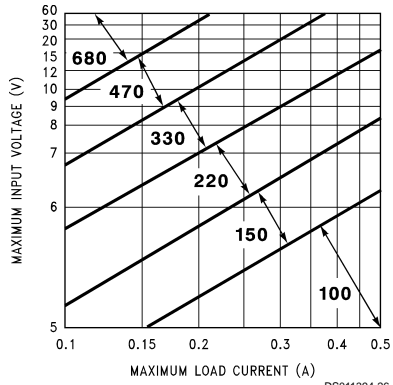

FIGURE 4. LM2574HV-3.3 Inductor Selection Guide

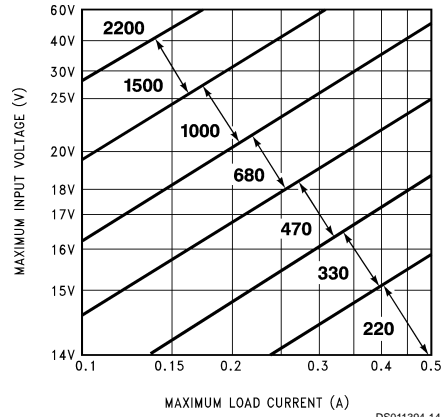

FIGURE 6. LM2574HV-12 Inductor Selection Guide

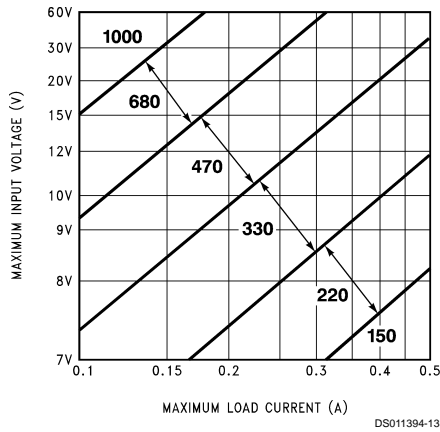

FIGURE 5. LM2574HV-5.0 Inductor Selection Guide

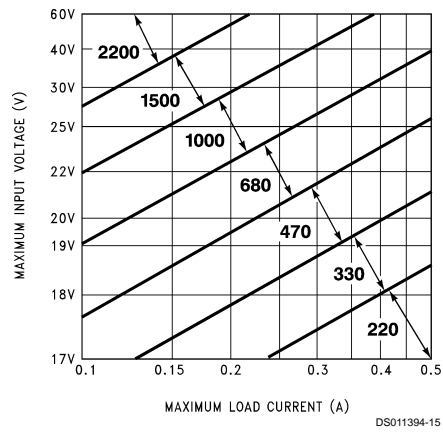

FIGURE 7. LM2574HV-15 Inductor Selection Guide

LM2574 Series Buck Regulator Design Procedure (Continued)

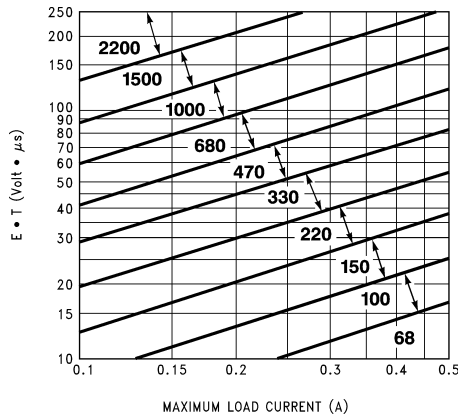

FIGURE 8. LM2574HV-ADJ Inductor Selection Guide

PROCEDURE (Adjustable Output Voltage Versions)	EXAMPLE (Adjustable Output Voltage Versions)
<p>Given: V_{OUT} = Regulated Output Voltage $V_{IN(Max)}$ = Maximum Input Voltage $I_{LOAD(Max)}$ = Maximum Load Current F = Switching Frequency (Fixed at 52 kHz)</p> <p>1. Programming Output Voltage (Selecting R_1 and R_2, as shown in Figure 2) Use the following formula to select the appropriate resistor values.</p> $V_{OUT} = V_{REF} \left(1 + \frac{R_2}{R_1} \right) \quad \text{where } V_{REF} = 1.23V$ <p>R_1 can be between 1k and 5k. (For best temperature coefficient and stability with time, use 1% metal film resistors)</p> $R_2 = R_1 \left(\frac{V_{OUT}}{V_{REF}} - 1 \right)$ <p>2. Inductor Selection (L1) A. Calculate the inductor Volt • microsecond constant, $E \cdot T$ ($V \cdot \mu s$), from the following formula:</p> $E \cdot T = (V_{IN} - V_{OUT}) \frac{V_{OUT}}{V_{IN}} \cdot \frac{1000}{F \text{ (in kHz)}} \text{ (} V \cdot \mu s \text{)}$ <p>B. Use the $E \cdot T$ value from the previous formula and match it with the $E \cdot T$ number on the vertical axis of the Inductor Value Selection Guide shown in Figure 8. C. On the horizontal axis, select the maximum load current. D. Identify the inductance region intersected by the $E \cdot T$ value and the maximum load current value, and note the inductor value for that region. E. Select an appropriate inductor from the table shown in Figure 3. Part numbers are listed for three inductor manufacturers. The inductor chosen must be rated for operation at the LM2574 switching frequency (52 kHz) and for a current rating of $1.5 \times I_{LOAD}$. For additional inductor information, see the inductor section in the application hints section of this data sheet.</p>	<p>Given: $V_{OUT} = 24V$ $V_{IN(Max)} = 40V$ $I_{LOAD(Max)} = 0.4A$ $F = 52 \text{ kHz}$</p> <p>1. Programming Output Voltage (Selecting R_1 and R_2)</p> $V_{OUT} = 1.23 \left(1 + \frac{R_2}{R_1} \right) \quad \text{Select } R_1 = 1k$ $R_2 = R_1 \left(\frac{V_{OUT}}{V_{REF}} - 1 \right) = 1k \left(\frac{24V}{1.23V} - 1 \right)$ <p>$R_2 = 1k (19.51 - 1) = 18.51k$, closest 1% value is 18.7k</p> <p>2. Inductor Selection (L1) A. Calculate $E \cdot T$ ($V \cdot \mu s$)</p> $E \cdot T = (40 - 24) \cdot \frac{24}{40} \cdot \frac{1000}{52} = 185 V \cdot \mu s$ <p>B. $E \cdot T = 185 V \cdot \mu s$ C. $I_{LOAD(Max)} = 0.4A$ D. Inductance Region = 1000 E. Inductor Value = 1000 μH Choose from Pulse Engineering Part #PE-52631, or Renco Part #RL-1283-1000.</p>

LM2574 Series Buck Regulator Design Procedure (Continued)

PROCEDURE (Adjustable Output Voltage Versions)	EXAMPLE (Adjustable Output Voltage Versions)
<p>3. Output Capacitor Selection (C_{OUT})</p> <p>A. The value of the output capacitor together with the inductor defines the dominate pole-pair of the switching regulator loop. For stable operation, the capacitor must satisfy the following requirement:</p> $C_{OUT} \geq 13,300 \frac{V_{IN(Max)}}{V_{OUT} \bullet L(\mu H)} (\mu F)$ <p>The above formula yields capacitor values between 5 μF and 1000 μF that will satisfy the loop requirements for stable operation. But to achieve an acceptable output ripple voltage, (approximately 1% of the output voltage) and transient response, the output capacitor may need to be several times larger than the above formula yields.</p> <p>B. The capacitor's voltage rating should be at least 1.5 times greater than the output voltage. For a 24V regulator, a rating of at least 35V is recommended.</p> <p>Higher voltage electrolytic capacitors generally have lower ESR numbers, and for this reason it may be necessary to select a capacitor rate for a higher voltage than would normally be needed.</p> <p>4. Catch Diode Selection (D1)</p> <p>A. The catch-diode current rating must be at least 1.5 times greater than the maximum load current. Also, if the power supply design must withstand a continuous output short, the diode should have a current rating equal to the maximum current limit of the LM2574. The most stressful condition for this diode is an overload or shorted output condition. Suitable diodes are shown in the selection guide of <i>Figure 9</i>.</p> <p>B. The reverse voltage rating of the diode should be at least 1.25 times the maximum input voltage.</p> <p>5. Input Capacitor (C_{IN})</p> <p>An aluminum or tantalum electrolytic bypass capacitor located close to the regulator is needed for stable operation.</p>	<p>3. Output Capacitor Selection (C_{OUT})</p> <p>A. $C_{OUT} > 13,300 \frac{40}{24 \bullet 1000} = 22.2 \mu F$</p> <p>However, for acceptable output ripple voltage select $C_{OUT} \geq 100 \mu F$ $C_{OUT} = 100 \mu F$ electrolytic capacitor</p> <p>4. Catch Diode Selection (D1)</p> <p>A. For this example, a 1A current rating is adequate. B. Use a 50V MBR150 or 11DQ05 Schottky diode, or any of the suggested fast-recovery diodes in <i>Figure 9</i>.</p> <p>5. Input Capacitor (C_{IN})</p> <p>A 22 μF aluminum electrolytic capacitor located near the input and ground pins provides sufficient bypassing. See (<i>Figure 9</i>). <i>To further simplify the buck regulator design procedure, National Semiconductor is making available computer design software to be used with the Simple Switcher line of switching regulators. Switchers Made Simple (version 3.3) is available on a (3 1/2") diskette for IBM compatible computers from a National Semiconductor sales office in your area.</i></p>

LM2574 Series Buck Regulator Design Procedure (Continued)

V _R	1 Amp Diodes		
	Schottky	Fast Recovery	
20V	1N5817 SR102 MBR120P		
30V	1N5818 SR103 11DQ03 MBR130P 10JQ030	The following diodes are all rated to 100V	
40V	1N5819 SR104 11DQ04 11JQ04 MBR140P		
50V	MBR150 SR105 11DQ05 11JQ05		11DF1 10JF1 MUR110 HER102
60V	MBR160 SR106 11DQ06 11JQ06		
90V	11DQ09		

FIGURE 9. Diode Selection Guide

Application Hints

INPUT CAPACITOR (C_{IN})

To maintain stability, the regulator input pin must be bypassed with at least a 22 μF electrolytic capacitor. The capacitor's leads must be kept short, and located near the regulator.

If the operating temperature range includes temperatures below -25°C, the input capacitor value may need to be larger. With most electrolytic capacitors, the capacitance value decreases and the ESR increases with lower temperatures and age. Paralleling a ceramic or solid tantalum capacitor will increase the regulator stability at cold temperatures. For maximum capacitor operating lifetime, the capacitor's RMS ripple current rating should be greater than

$$1.2 \times \left(\frac{t_{ON}}{T} \right) \times I_{LOAD}$$

$$\text{where } \frac{t_{ON}}{T} = \frac{V_{OUT}}{V_{IN}} \text{ for a buck regulator}$$

$$\text{and } \frac{t_{ON}}{T} = \frac{|V_{OUT}|}{|V_{OUT}| + V_{IN}} \text{ for a buck-boost regulator.}$$

INDUCTOR SELECTION

All switching regulators have two basic modes of operation: continuous and discontinuous. The difference between the two types relates to the inductor current, whether it is flowing continuously, or if it drops to zero for a period of time in the normal switching cycle. Each mode has distinctively different operating characteristics, which can affect the regulator performance and requirements.

The LM2574 (or any of the Simple Switcher family) can be used for both continuous and discontinuous modes of operation.

In many cases the preferred mode of operation is in the continuous mode. It offers better load regulation, lower peak switch, inductor and diode currents, and can have lower output ripple voltage. But it does require relatively large inductor values to keep the inductor current flowing continuously, especially at low output load currents.

To simplify the inductor selection process, an inductor selection guide (nomograph) was designed (see Figure 4 through Figure 8). This guide assumes continuous mode operation, and selects an inductor that will allow a peak-to-peak inductor ripple current (ΔI_{IND}) to be a certain percentage of the maximum design load current. In the LM2574 SIMPLE SWITCHER, the peak-to-peak inductor ripple current percentage (of load current) is allowed to change as different design load currents are selected. By allowing the percentage of inductor ripple current to increase for lower current applications, the inductor size and value can be kept relatively low.

Application Hints (Continued)

INDUCTOR RIPPLE CURRENT

When the switcher is operating in the continuous mode, the inductor current waveform ranges from a triangular to a sawtooth type of waveform (depending on the input voltage). For a given input voltage and output voltage, the peak-to-peak amplitude of this inductor current waveform remains constant. As the load current rises or falls, the entire sawtooth current waveform also rises or falls. The average DC value of this waveform is equal to the DC load current (in the buck regulator configuration).

If the load current drops to a low enough level, the bottom of the sawtooth current waveform will reach zero, and the switcher will change to a discontinuous mode of operation. This is a perfectly acceptable mode of operation. Any buck switching regulator (no matter how large the inductor value is) will be forced to run discontinuous if the load current is light enough.

The curve shown in *Figure 10* illustrates how the peak-to-peak inductor ripple current (ΔI_{IND}) is allowed to change as different maximum load currents are selected, and also how it changes as the operating point varies from the upper border to the lower border within an inductance region (see Inductor Selection guides).

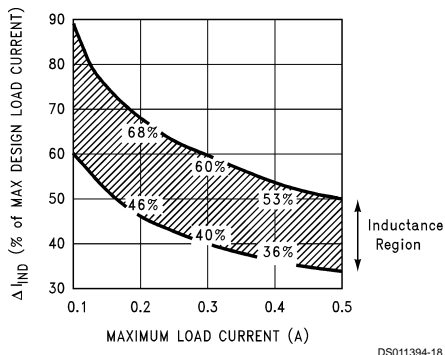

FIGURE 10. Inductor Ripple Current (ΔI_{IND}) Range Based on Selection Guides from Figure 4 through Figure 8.

Consider the following example:

$$V_{OUT} = 5V @ 0.4A$$

$$V_{IN} = 10V \text{ minimum up to } 20V \text{ maximum}$$

The selection guide in *Figure 5* shows that for a 0.4A load current, and an input voltage range between 10V and 20V, the inductance region selected by the guide is 330 μ H. This value of inductance will allow a peak-to-peak inductor ripple current (ΔI_{IND}) to flow that will be a percentage of the maximum load current. For this inductor value, the ΔI_{IND} will also vary depending on the input voltage. As the input voltage increases to 20V, it approaches the upper border of the inductance region, and the inductor ripple current increases. Referring to the curve in *Figure 10*, it can be seen that at the 0.4A load current level, and operating near the upper border of the 330 μ H inductance region, the ΔI_{IND} will be 53% of 0.4A, or 212 mA p-p.

This ΔI_{IND} is important because from this number the peak inductor current rating can be determined, the minimum load current required before the circuit goes to discontinuous operation, and also, knowing the ESR of the output capacitor,

the output ripple voltage can be calculated, or conversely, measuring the output ripple voltage and knowing the ΔI_{IND} , the ESR can be calculated.

From the previous example, the Peak-to-peak Inductor Ripple Current (ΔI_{IND}) = 212 mA p-p. Once the ΔI_{IND} value is known, the following three formulas can be used to calculate additional information about the switching regulator circuit:

1. Peak Inductor or peak switch current

$$= \left(I_{LOAD} + \frac{\Delta I_{IND}}{2} \right) = \left(0.4A + \frac{212}{2} \right) = 506 \text{ mA}$$

2. Minimum load current before the circuit becomes discontinuous

$$= \frac{\Delta I_{IND}}{2} = \frac{212}{2} = 106 \text{ mA}$$

3. Output Ripple Voltage = (ΔI_{IND}) x (ESR of C_{OUT})

The selection guide chooses inductor values suitable for continuous mode operation, but if the inductor value chosen is prohibitively high, the designer should investigate the possibility of discontinuous operation. The computer design software **Switchers Made Simple** will provide all component values for discontinuous (as well as continuous) mode of operation.

Inductors are available in different styles such as pot core, toroid, E-frame, bobbin core, etc., as well as different core materials, such as ferrites and powdered iron. The least expensive, the bobbin core type, consists of wire wrapped on a ferrite rod core. This type of construction makes for an inexpensive inductor, but since the magnetic flux is not completely contained within the core, it generates more electromagnetic interference (EMI). This EMI can cause problems in sensitive circuits, or can give incorrect scope readings because of induced voltages in the scope probe.

The inductors listed in the selection chart include powdered iron toroid for Pulse Engineering, and ferrite bobbin core for Renco.

An inductor should not be operated beyond its maximum rated current because it may saturate. When an inductor begins to saturate, the inductance decreases rapidly and the inductor begins to look mainly resistive (the DC resistance of the winding). This can cause the inductor current to rise very rapidly and will affect the energy storage capabilities of the inductor and could cause inductor overheating. Different inductor types have different saturation characteristics, and this should be kept in mind when selecting an inductor. The inductor manufacturers' data sheets include current and energy limits to avoid inductor saturation.

OUTPUT CAPACITOR

An output capacitor is required to filter the output voltage and is needed for loop stability. The capacitor should be located near the LM2574 using short pc board traces. Standard aluminum electrolytics are usually adequate, but low ESR types are recommended for low output ripple voltage and good stability. The ESR of a capacitor depends on many factors, some which are: the value, the voltage rating, physical size and the type of construction. In general, low value or low voltage (less than 12V) electrolytic capacitors usually have higher ESR numbers.

The amount of output ripple voltage is primarily a function of the ESR (Equivalent Series Resistance) of the output ca-

Application Hints (Continued)

capacitor and the amplitude of the inductor ripple current (ΔI_{IND}). See the section on inductor ripple current in Application Hints.

The lower capacitor values (100 μ F- 330 μ F) will allow typically 50 mV to 150 mV of output ripple voltage, while larger-value capacitors will reduce the ripple to approximately 20 mV to 50 mV.

Output Ripple Voltage = (ΔI_{IND}) (ESR of C_{OUT})

To further reduce the output ripple voltage, several standard electrolytic capacitors may be paralleled, or a higher-grade capacitor may be used. Such capacitors are often called "high-frequency," "low-inductance," or "low-ESR." These will reduce the output ripple to 10 mV or 20 mV. However, when operating in the continuous mode, reducing the ESR below 0.03 Ω can cause instability in the regulator.

Tantalum capacitors can have a very low ESR, and should be carefully evaluated if it is the only output capacitor. Because of their good low temperature characteristics, a tantalum can be used in parallel with aluminum electrolytics, with the tantalum making up 10% or 20% of the total capacitance. The capacitor's ripple current rating at 52 kHz should be at least 50% higher than the peak-to-peak inductor ripple current.

CATCH DIODE

Buck regulators require a diode to provide a return path for the inductor current when the switch is off. This diode should be located close to the LM2574 using short leads and short printed circuit traces.

Because of their fast switching speed and low forward voltage drop, Schottky diodes provide the best efficiency, especially in low output voltage switching regulators (less than 5V). Fast-Recovery, High-Efficiency, or Ultra-Fast Recovery diodes are also suitable, but some types with an abrupt turn-off characteristic may cause instability and EMI problems. A fast-recovery diode with soft recovery characteristics is a better choice. Standard 60 Hz diodes (e.g., 1N4001 or 1N5400, etc.) are also **not suitable**. See *Figure 9* for Schottky and "soft" fast-recovery diode selection guide.

OUTPUT VOLTAGE RIPPLE AND TRANSIENTS

The output voltage of a switching power supply will contain a sawtooth ripple voltage at the switcher frequency, typically about 1% of the output voltage, and may also contain short voltage spikes at the peaks of the sawtooth waveform.

The output ripple voltage is due mainly to the inductor sawtooth ripple current multiplied by the ESR of the output capacitor. (See the inductor selection in the application hints.)

The voltage spikes are present because of the the fast switching action of the output switch, and the parasitic inductance of the output filter capacitor. To minimize these voltage spikes, special low inductance capacitors can be used, and their lead lengths must be kept short. Wiring inductance, stray capacitance, as well as the scope probe used to evaluate these transients, all contribute to the amplitude of these spikes.

An additional small LC filter (20 μ H & 100 μ F) can be added to the output (as shown in *Figure 16*) to further reduce the amount of output ripple and transients. A 10 x reduction in output ripple voltage and transients is possible with this filter.

FEEDBACK CONNECTION

The LM2574 (fixed voltage versions) feedback pin must be wired to the output voltage point of the switching power supply. When using the adjustable version, physically locate both output voltage programming resistors near the LM2574 to avoid picking up unwanted noise. Avoid using resistors greater than 100 k Ω because of the increased chance of noise pickup.

\overline{ON} /OFF INPUT

For normal operation, the \overline{ON} /OFF pin should be grounded or driven with a low-level TTL voltage (typically below 1.6V). To put the regulator into standby mode, drive this pin with a high-level TTL or CMOS signal. The \overline{ON} /OFF pin can be safely pulled up to + V_{IN} without a resistor in series with it. The \overline{ON} /OFF pin should not be left open.

GROUNDING

The 8-pin molded DIP and the 14-pin surface mount package have separate power and signal ground pins. Both ground pins should be soldered directly to wide printed circuit board copper traces to assure low inductance connections and good thermal properties.

THERMAL CONSIDERATIONS

The 8-pin DIP (N) package and the 14-pin Surface Mount (M) package are molded plastic packages with solid copper lead frames. The copper lead frame conducts the majority of the heat from the die, through the leads, to the printed circuit board copper, which acts as the heat sink. For best thermal performance, wide copper traces should be used, and all ground and unused pins should be soldered to generous amounts of printed circuit board copper, such as a ground plane. Large areas of copper provide the best transfer of heat (lower thermal resistance) to the surrounding air, and even double-sided or multilayer boards provide better heat paths to the surrounding air. Unless the power levels are small, using a socket for the 8-pin package is not recommended because of the additional thermal resistance it introduces, and the resultant higher junction temperature.

Because of the 0.5A current rating of the LM2574, the total package power dissipation for this switcher is quite low, ranging from approximately 0.1W up to 0.75W under varying conditions. In a carefully engineered printed circuit board, both the N and the M package can easily dissipate up to 0.75W, even at ambient temperatures of 60°C, and still keep the maximum junction temperature below 125°C.

A curve displaying thermal resistance vs. pc board area for the two packages is shown in the Typical Performance Characteristics curves section of this data sheet.

These thermal resistance numbers are approximate, and there can be many factors that will affect the final thermal resistance. Some of these factors include board size, shape, thickness, position, location, and board temperature. Other factors are, the area of printed circuit copper, copper thickness, trace width, multi-layer, single- or double-sided, and the amount of solder on the board. The effectiveness of the pc board to dissipate heat also depends on the size, number and spacing of other components on the board. Furthermore, some of these components, such as the catch diode and inductor will generate some additional heat. Also, the thermal resistance decreases as the power level increases because of the increased air current activity at the higher power levels, and the lower surface to air resistance coefficient at higher temperatures.

Application Hints (Continued)

The data sheet thermal resistance curves and the thermal model in **Switchers Made Simple** software (version 3.3) can estimate the maximum junction temperature based on operating conditions. In addition, the junction temperature can be estimated in actual circuit operation by using the following equation.

$$T_j = T_{cu} + (\theta_{j-cu} \times P_D)$$

With the switcher operating under worst case conditions and all other components on the board in the intended enclosure, measure the copper temperature (T_{cu}) near the IC. This can be done by temporarily soldering a small thermocouple to the pc board copper near the IC, or by holding a small thermocouple on the pc board copper using thermal grease for good thermal conduction.

The thermal resistance (θ_{j-cu}) for the two packages is:

$$\theta_{j-cu} = 42^\circ\text{C/W for the N-8 package}$$

$$\theta_{j-cu} = 52^\circ\text{C/W for the M-14 package}$$

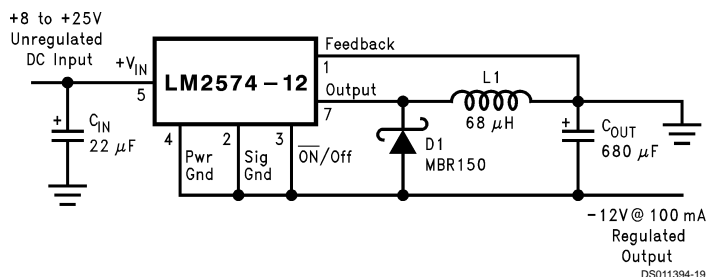

Note: Pin numbers are for the 8-pin DIP package.

FIGURE 11. Inverting Buck-Boost Develops -12V

For an input voltage of 8V or more, the maximum available output current in this configuration is approximately 100 mA. At lighter loads, the minimum input voltage required drops to approximately 4.7V.

The switch currents in this buck-boost configuration are higher than in the standard buck-mode design, thus lowering the available output current. Also, the start-up input current of the buck-boost converter is higher than the standard buck-mode regulator, and this may overload an input power source with a current limit less than 0.6A. Using a delayed turn-on or an undervoltage lockout circuit (described in the next section) would allow the input voltage to rise to a high enough level before the switcher would be allowed to turn on.

Because of the structural differences between the buck and the buck-boost regulator topologies, the buck regulator design procedure section can not be used to select the inductor or the output capacitor. The recommended range of inductor values for the buck-boost design is between 68 μH and 220 μH , and the output capacitor values must be larger than what is normally required for buck designs. Low input voltages or high output currents require a large value output capacitor (in the thousands of micro Farads).

The peak inductor current, which is the same as the peak switch current, can be calculated from the following formula:

$$I_p \approx \frac{I_{LOAD}(V_{IN} + |V_O|)}{V_{IN}} + \frac{V_{IN}|V_O|}{V_{IN} + |V_O|} \times \frac{1}{2L_1 f_{osc}}$$

The power dissipation (P_D) for the IC could be measured, or it can be estimated by using the formula:

$$P_D = (V_{IN}) (I_S) + \left(\frac{V_O}{V_{IN}} \right) (I_{LOAD}) (V_{SAT})$$

Where I_S is obtained from the typical supply current curve (adjustable version use the supply current vs. duty cycle curve).

Additional Applications

INVERTING REGULATOR

Figure 11 shows a LM2574-12 in a buck-boost configuration to generate a negative 12V output from a positive input voltage. This circuit bootstraps the regulator's ground pin to the negative output voltage, then by grounding the feedback pin, the regulator senses the inverted output voltage and regulates it to -12V.

Where $f_{osc} = 52 \text{ kHz}$. Under normal continuous inductor current operating conditions, the minimum V_{IN} represents the worst case. Select an inductor that is rated for the peak current anticipated.

Also, the maximum voltage appearing across the regulator is the absolute sum of the input and output voltage. For a -12V output, the maximum input voltage for the LM2574 is +28V, or +48V for the LM2574HV.

The **Switchers Made Simple** version 3.3) design software can be used to determine the feasibility of regulator designs using different topologies, different input-output parameters, different components, etc.

NEGATIVE BOOST REGULATOR

Another variation on the buck-boost topology is the negative boost configuration. The circuit in Figure 12 accepts an input voltage ranging from -5V to -12V and provides a regulated -12V output. Input voltages greater than -12V will cause the output to rise above -12V, but will not damage the regulator.

Additional Applications (Continued)

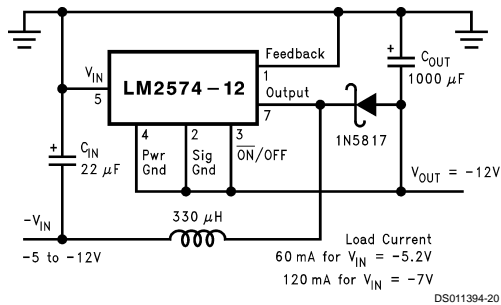

Note: Pin numbers are for 8-pin DIP package.

FIGURE 12. Negative Boost

Because of the boosting function of this type of regulator, the switch current is relatively high, especially at low input voltages. Output load current limitations are a result of the maximum current rating of the switch. Also, boost regulators can not provide current limiting load protection in the event of a shorted load, so some other means (such as a fuse) may be necessary.

UNDERVOLTAGE LOCKOUT

In some applications it is desirable to keep the regulator off until the input voltage reaches a certain threshold. An undervoltage lockout circuit which accomplishes this task is shown in Figure 13 while Figure 14 shows the same circuit applied to a buck-boost configuration. These circuits keep the regulator off until the input voltage reaches a predetermined level.

$$V_{TH} = V_{Z1} + 2V_{BE}(Q1)$$

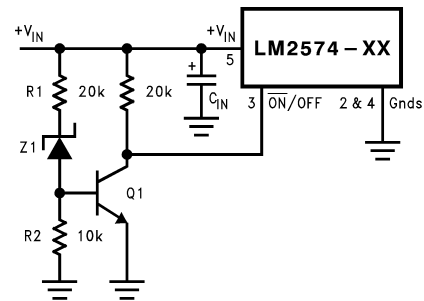

Note: Complete circuit not shown.

Note: Pin numbers are for 8-pin DIP package.

FIGURE 13. Undervoltage Lockout for Buck Circuit

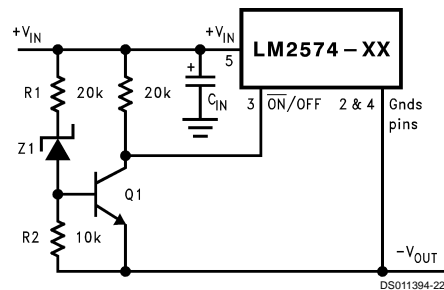

Note: Complete circuit not shown (see Figure 11).

Note: Pin numbers are for 8-pin DIP package.

FIGURE 14. Undervoltage Lockout for Buck-Boost Circuit

DELAYED STARTUP

The $\overline{\text{ON}}/\text{OFF}$ pin can be used to provide a delayed startup feature as shown in Figure 15. With an input voltage of 20V and for the part values shown, the circuit provides approximately 10 ms of delay time before the circuit begins switching. Increasing the RC time constant can provide longer delay times. But excessively large RC time constants can cause problems with input voltages that are high in 60 Hz or 120 Hz ripple, by coupling the ripple into the $\overline{\text{ON}}/\text{OFF}$ pin.

ADJUSTABLE OUTPUT, LOW-RIPPLE POWER SUPPLY

A 500 mA power supply that features an adjustable output voltage is shown in Figure 16. An additional L-C filter that reduces the output ripple by a factor of 10 or more is included in this circuit.

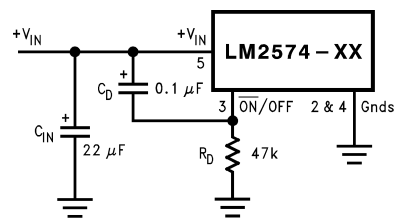

Note: Complete circuit not shown.

Note: Pin numbers are for 8-pin DIP package.

FIGURE 15. Delayed Startup

Additional Applications (Continued)

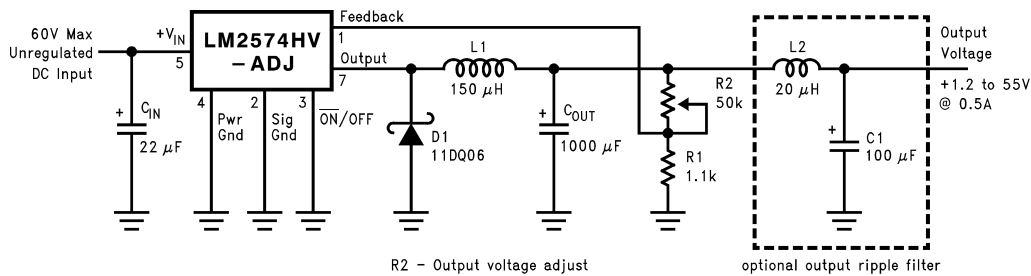

Note: Pin numbers are for 8-pin DIP package.

DS011394-24

FIGURE 16. 1.2V to 55V Adjustable 500 mA Power Supply with Low Output Ripple

Definition of Terms

BUCK REGULATOR

A switching regulator topology in which a higher voltage is converted to a lower voltage. Also known as a step-down switching regulator.

BUCK-BOOST REGULATOR

A switching regulator topology in which a positive voltage is converted to a negative voltage without a transformer.

DUTY CYCLE (D)

Ratio of the output switch's on-time to the oscillator period.

$$\text{for buck regulator} \quad D = \frac{t_{ON}}{T} = \frac{V_{OUT}}{V_{IN}}$$

$$\text{for buck-boost regulator} \quad D = \frac{t_{ON}}{T} = \frac{|V_O|}{|V_O| + V_{IN}}$$

CATCH DIODE OR CURRENT STEERING DIODE

The diode which provides a return path for the load current when the LM2574 switch is OFF.

EFFICIENCY (η)

The proportion of input power actually delivered to the load.

$$\eta = \frac{P_{OUT}}{P_{IN}} = \frac{P_{OUT}}{P_{OUT} + P_{LOSS}}$$

CAPACITOR EQUIVALENT SERIES RESISTANCE (ESR)

The purely resistive component of a real capacitor's impedance (see Figure 17). It causes power loss resulting in capacitor heating, which directly affects the capacitor's operating lifetime. When used as a switching regulator output filter, higher ESR values result in higher output ripple voltages.

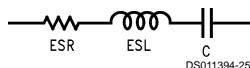

FIGURE 17. Simple Model of a Real Capacitor

Most standard aluminum electrolytic capacitors in the 100 µF–1000 µF range have 0.5Ω to 0.1Ω ESR. Higher-

grade capacitors ("low-ESR", "high-frequency", or "low-inductance") in the 100 µF–1000 µF range generally have ESR of less than 0.15Ω.

EQUIVALENT SERIES INDUCTANCE (ESL)

The pure inductance component of a capacitor (see Figure 17). The amount of inductance is determined to a large extent on the capacitor's construction. In a buck regulator, this unwanted inductance causes voltage spikes to appear on the output.

OUTPUT RIPPLE VOLTAGE

The AC component of the switching regulator's output voltage. It is usually dominated by the output capacitor's ESR multiplied by the inductor's ripple current (ΔI_{IND}). The peak-to-peak value of this sawtooth ripple current can be determined by reading the Inductor Ripple Current section of the Application hints.

CAPACITOR RIPPLE CURRENT

RMS value of the maximum allowable alternating current at which a capacitor can be operated continuously at a specified temperature.

STANDBY QUIESCENT CURRENT (I_{STBY})

Supply current required by the LM2574 when in the standby mode ($\overline{\text{ON/OFF}}$ pin is driven to TTL-high voltage, thus turning the output switch OFF).

INDUCTOR RIPPLE CURRENT (ΔI_{IND})

The peak-to-peak value of the inductor current waveform, typically a sawtooth waveform when the regulator is operating in the continuous mode (vs. discontinuous mode).

CONTINUOUS/DISCONTINUOUS MODE OPERATION

Relates to the inductor current. In the continuous mode, the inductor current is always flowing and never drops to zero, vs. the discontinuous mode, where the inductor current drops to zero for a period of time in the normal switching cycle.

Definition of Terms (Continued)

INDUCTOR SATURATION

The condition which exists when an inductor cannot hold any more magnetic flux. When an inductor saturates, the inductor appears less inductive and the resistive component dominates. Inductor current is then limited only by the DC resistance of the wire and the available source current.

OPERATING VOLT MICROSECOND CONSTANT ($E \cdot T_{op}$)

The product (in Volt $\cdot\mu$ s) of the voltage applied to the inductor and the time the voltage is applied. This $E \cdot T_{op}$ constant is a measure of the energy handling capability of an inductor and is dependent upon the type of core, the core area, the number of turns, and the duty cycle.

Physical Dimensions inches (millimeters) unless otherwise noted

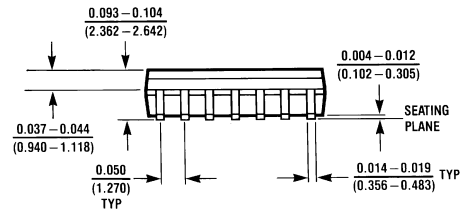
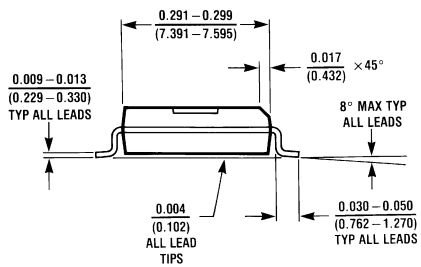
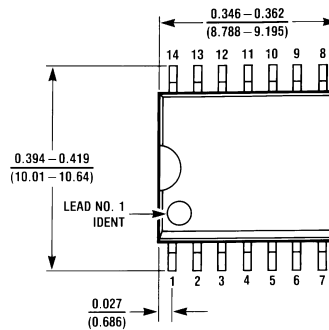

M14B (REV D)

14-Lead Wide Surface Mount (WM)
Order Number LM2574M-3.3, LM2574HVM-3.3, LM2574M-5.0,
LM2574HVM-5.0, LM2574M-12, LM2574HVM-12, LM2574M-15,
LM2574HVM-15, LM2574M-ADJ or LM2574HVM-ADJ
NS Package Number M14B

Physical Dimensions inches (millimeters) unless otherwise noted (Continued)

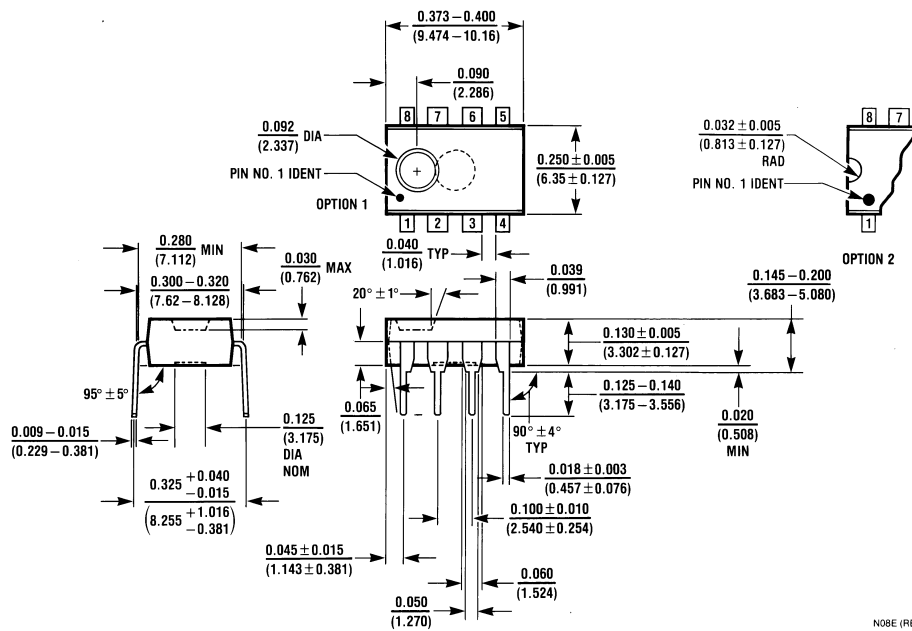

N08E (REV F)

8-Lead DIP (N)
Order Number LM2574M-3.3, LM2574HVM-3.3, LM2574HVN-5.0, LM2574HVN-12, LM2574HVN-15, LM2574HVN-ADJ, LM2574N-5.0, LM2574N-12, LM2574N-15 or LM2574N-ADJ
NS Package Number N08A

LIFE SUPPORT POLICY

NATIONAL'S PRODUCTS ARE NOT AUTHORIZED FOR USE AS CRITICAL COMPONENTS IN LIFE SUPPORT DEVICES OR SYSTEMS WITHOUT THE EXPRESS WRITTEN APPROVAL OF THE PRESIDENT AND GENERAL COUNSEL OF NATIONAL SEMICONDUCTOR CORPORATION. As used herein:

1. Life support devices or systems are devices or systems which, (a) are intended for surgical implant into the body, or (b) support or sustain life, and whose failure to perform when properly used in accordance with instructions for use provided in the labeling, can be reasonably expected to result in a significant injury to the user.
2. A critical component is any component of a life support device or system whose failure to perform can be reasonably expected to cause the failure of the life support device or system, or to affect its safety or effectiveness.

 **National Semiconductor Corporation**
 Americas
 Tel: 1-800-272-9959
 Fax: 1-800-737-7018
 Email: support@nsc.com

National Semiconductor Europe
 Fax: +49 (0) 1 80-530 85 86
 Email: europe.support@nsc.com
 Deutsch Tel: +49 (0) 1 80-530 85 85
 English Tel: +49 (0) 1 80-532 78 32
 Français Tel: +49 (0) 1 80-532 93 58
 Italiano Tel: +49 (0) 1 80-534 16 80

National Semiconductor Asia Pacific Customer Response Group
 Tel: 65-2544466
 Fax: 65-2504466
 Email: sea.support@nsc.com

National Semiconductor Japan Ltd.
 Tel: 81-3-5639-7560
 Fax: 81-3-5639-7507

www.national.com

[Products](#) > [Analog - Regulators](#) > [Simple Switchers](#) > [LM2574](#)

LM2574 Product Folder

SIMPLE SWITCHER 0.5A Step-Down Voltage Regulator

See Also: [LM2594](#) - lower cost, higher efficiency, smaller solution size
[LM2597](#) - lower cost, higher efficiency, smaller solution size
[LM2674](#) - very high efficiency, much smaller solution size
[LM2671](#) - LOWER COST, HIGHER EFFICIENCY, SMALLER SOLUTION SIZE.

[General Description](#)

[Features](#)

[Datasheet](#)

[Package & Models](#)

[Samples & Pricing](#)

[Design Tools](#)

[Application Notes](#)

WEBENCH Live Simulation!

LM2574 Webench™ Custom Design/Analyze/Build It

	V in Lower		V in Upper	
4.8 <=	V <=		V <=	40.0
V out	1.2 <=		V <=	37.0
I out			A <=	0.50
Ambient Temperature			°C <=	100

[What is Webench?](#)

Parametric Table

Multiple Output Capability	No
On/Off Pin	Yes
Error Flag	No
Input Voltage, min (Volt)	4
Input Voltage, max (Volt)	40, 60
Output Current, max	500 mA
Output Voltage (Volt)	12, 15, 3.30, 5
Adjustable Output Voltage	No, Yes
Switching Frequency (Hz)	52000
Adjustable Switching Frequency	No
Sync Pin	No
Efficiency (%)	88, 72, 77
Flyback	No
Inverting	Yes
Step-down	Yes

Datasheet

Title	Size in Kbytes	Date	<input type="checkbox"/> View Online	<input type="checkbox"/> Download	<input type="checkbox"/> Receive via Email
LM2574 LM2574HV SIMPLE SWITCHER 0.5A Step-Down Voltage Regulator	639 Kbytes	30-Jun-99	View Online	Download	Receive via Email
LM2574 LM2574HV SIMPLE SWITCHER 0.5A Step-Down Voltage Regulator (JAPANESE)	840 Kbytes		View Online	Download	Receive via

Package Availability, Models, Samples & Pricing

Part Number	Package			Status	Models		Samples & Electronic Orders	Budgetary Pricing		Std Pack Size	Package Marking
	Type	Pins	MSL		SPICE	IBIS		Qty	\$US each		
LM2574M-12	SOIC WIDE	14	MSL	Full production	N/A	N/A	24 Hour Buy Now	1K+	\$0.7200	rail of 50	[logo]cUcZc2cT LM2574M -12 P+
LM2574M-15	SOIC WIDE	14	MSL	Full production	N/A	N/A		1K+	\$0.7200	rail of 50	[logo]cUcZc2cT LM2574M -15 P+
LM2574M-3.3	SOIC WIDE	14	MSL	Full production	N/A	N/A	24 Hour Buy Now	1K+	\$0.7200	rail of 50	[logo]cUcZc2cT LM2574M -3.3 P+
LM2574M-5.0	SOIC WIDE	14	MSL	Full production	N/A	N/A	24 Hour Buy Now	1K+	\$0.7200	rail of 50	[logo]cUcZc2cT LM2574M -5.0 P+
LM2574M-ADJ	SOIC WIDE	14	MSL	Full production	N/A	N/A	Samples Buy Now	1K+	\$0.7200	rail of 50	[logo]cUcZc2cT LM2574M -ADJ P+
LM2574MX-12	SOIC WIDE	14	MSL	Full production	N/A	N/A	Buy Now	1K+	\$0.7200	reel of 1000	[logo]cUcZc2cT LM2574M -12 P+
LM2574MX-15	SOIC WIDE	14	MSL	Full production	N/A	N/A		1K+	\$0.7200	reel of 1000	[logo]cUcZc2cT LM2574M -15 P+
LM2574MX-3.3	SOIC WIDE	14	MSL	Full production	N/A	N/A		1K+	\$0.7200	reel of 1000	[logo]cUcZc2cT LM2574M -3.3 P+
LM2574MX-5.0	SOIC WIDE	14	MSL	Full production	N/A	N/A	Buy Now	1K+	\$0.7200	reel of 1000	[logo]cUcZc2cT LM2574M -5.0 P+
LM2574MX-ADJ	SOIC WIDE	14	MSL	Full production	N/A	N/A	Buy Now	1K+	\$0.7200	reel of 1000	[logo]cUcZc2cT LM2574M -ADJ P+
LM2574N-12	MDIP	8	MSL	Full production	N/A	N/A	24 Hour Buy Now	1K+	\$0.7200	rail of 40	[logo]cUcZc2cT LM2574N -12 P+
LM2574N-15	MDIP	8	MSL	Full production	N/A	N/A	24 Hour Buy Now	1K+	\$0.7200	rail of 40	[logo]cUcZc2cT LM2574N -15 P+
LM2574N-3.3	MDIP	8	MSL	Full production	N/A	N/A	Samples Buy Now	1K+	\$0.7200	rail of 40	[logo]cUcZc2cT LM2574N -3.3 P+

LM2574N-5.0	MDIP	8	MSL	Full production	N/A	N/A	24 Hour Buy Now	1K+	\$0.7200	rail of 40	[logo]cUcZc2cT LM2574N -5.0 P+
LM2574N-ADJ	MDIP	8	MSL	Full production	N/A	N/A	24 Hour Buy Now	1K+	\$0.7200	rail of 40	[logo]cUcZc2cT LM2574N -ADJ P+
LM2574-12 MDC	Die			Full production	N/A	N/A	Samples			tray of N/A	-
LM2574-15 MDC	Die			Full production	N/A	N/A	Samples			tray of N/A	-
LM2574-3.3 MDC	Die			Full production	N/A	N/A	Samples			tray of N/A	-
LM2574-5.0 MDC	Die			Full production	N/A	N/A	Samples			tray of N/A	-
LM2574-ADJ MDC	Die			Full production	N/A	N/A	Samples			tray of N/A	-
LM2574HV-12 MDC	Die			Full production	N/A	N/A	Samples			tray of N/A	-
LM2574HV-15 MDC	Die			Full production	N/A	N/A	Samples			tray of N/A	-
LM2574HV3.3 MDC	Die			Full production	N/A	N/A	Samples			tray of N/A	-
LM2574HVADJ MDC	Die			Full production	N/A	N/A	Samples			tray of N/A	-
LM2574-12 MWC	Wafer			Full production	N/A	N/A				wafer jar of N/A	-
LM2574-15 MWC	Wafer			Full production	N/A	N/A				wafer jar of N/A	-
LM2574-3.3 MWC	Wafer			Full production	N/A	N/A				wafer jar of N/A	-
LM2574-5.0 MWC	Wafer			Full production	N/A	N/A				wafer jar of N/A	-
LM2574-ADJ MWC	Wafer			Full production	N/A	N/A				wafer jar of N/A	-

LM2574HV-12 MWC	Wafer	Full production	N/A	N/A				wafer jar of N/A	-
LM2574HV-15 MWC	Wafer	Full production	N/A	N/A				wafer jar of N/A	-
LM2574HV3.3 MWC	Wafer	Full production	N/A	N/A				wafer jar of N/A	-
LM2574HVADJ MWC	Wafer	Full production	N/A	N/A				wafer jar of N/A	-

General Description

The LM2574 series of regulators are monolithic integrated circuits that provide all the active functions for a step-down (buck) switching regulator, capable of driving a 0.5A load with excellent line and load regulation. These devices are available in fixed output voltages of 3.3V, 5V, 12V, 15V, and an adjustable output version.

Requiring a minimum number of external components, these regulators are simple to use and include internal frequency compensation and a fixed-frequency oscillator.

The LM2574 series offers a high-efficiency replacement for popular three-terminal linear regulators. Because of its high efficiency, the copper traces on the printed circuit board are normally the only heat sinking needed.

A standard series of inductors optimized for use with the LM2574 are available from several different manufacturers. This feature greatly simplifies the design of switch-mode power supplies.

Other features include a guaranteed $\pm 4\%$ tolerance on output voltage within specified input voltages and output load conditions, and $\pm 10\%$ on the oscillator frequency. External shutdown is included, featuring 50 μA (typical) standby current. The output switch includes cycle-by-cycle current limiting, as well as thermal shutdown for full protection under fault conditions.

Features

- 3.3V, 5V, 12V, 15V, and adjustable output versions
- Adjustable version output voltage range, 1.23V to 37V (57V for HV version) $\pm 4\%$ max over line and load conditions
- Guaranteed 0.5A output current
- Wide input voltage range, 40V, up to 60V for HV version
- Requires only 4 external components
- 52 kHz fixed frequency internal oscillator
- TTL shutdown capability, low power standby mode
- High efficiency
- Uses readily available standard inductors
- Thermal shutdown and current limit protection

Applications

- Simple high-efficiency step-down (buck) regulator
- Efficient pre-regulator for linear regulators
- On-card switching regulators
- Positive to negative converter (Buck-Boost)

Design Tools

Title	Size in Kbytes	Date	<input type="checkbox"/> View Online	<input type="checkbox"/> Download	<input type="checkbox"/> Receive via Email
SimpleSwitcher® DC-DC Converters Design Software	10 Kbytes	12-Jun-2002	View		

If you have trouble printing or viewing PDF file(s), see [Printing Problems](#).

Application Notes

Title	Size in Kbytes	Date	<input type="checkbox"/> View Online	<input type="checkbox"/> Download	<input type="checkbox"/> Receive via Email
AN-1061: AN-1061 Power Conversion in Line-Powered Equipment	142 Kbytes	5-Jan-97	View Online	Download	Receive via Email
AN-1229: Application Note 1229 SIMPLE SWITCHER PCB Layout Guidelines	229 Kbytes	29-Jul-02	View Online	Download	Receive via Email

If you have trouble printing or viewing PDF file(s), see [Printing Problems](#).

[Information as of 5-Aug-2002]

[Search](#) **[Design](#)** **[Purchasing](#)** **[Quality](#)** **[Company](#)** **[Home](#)**

[About Languages](#) . [Website Guide](#) . [About "Cookies"](#) . National is [QS 9000 Certified](#) . [Privacy/Security Statement](#) . [Contact Us](#) . [Site Terms & Conditions of Use](#) . Copyright 2002 © National Semiconductor Corporation . [My Preferences](#) . **[Feedback](#)**

LM2574HV Product Folder

SIMPLE SWITCHER 0.5A Step-Down Voltage Regulator

[General Description](#)

[Features](#)

[Datasheet](#)

[Package & Models](#)

[Samples & Pricing](#)

[Application Notes](#)

WEBENCH Live Simulation!

LM2574HV Webench™ Custom Design/Analyze/Build It

V in Lower	V in Upper
4.8 <= V <=	V <= 60.0
V out 1.2 <=	V <= 57.0
I out	A <= 0.50
Ambient Temperature	°C <= 100

[What is Webench?](#)

Parametric Table

Multiple Output Capability	No
On/Off Pin	Yes
Error Flag	No
Input Voltage, min (Volt)	4
Input Voltage, max (Volt)	60
Output Current, max	500 mA
Output Voltage (Volt)	12, 15, 3.30, 5
Adjustable Output Voltage	No, Yes
Switching Frequency (Hz)	52000
Adjustable Switching Frequency	No
Sync Pin	No
Efficiency (%)	88, 72, 77
Flyback	No
Inverting	Yes
Step-down	Yes

Datasheet

Title	Size in Kbytes	Date	<input type="checkbox"/> View Online	<input type="checkbox"/> Download	<input type="checkbox"/> Receive via Email
LM2574 LM2574HV SIMPLE SWITCHER 0.5A Step-Down Voltage Regulator	639 Kbytes	30-Jun-99	View Online	Download	Receive via Email
LM2574 LM2574HV SIMPLE SWITCHER 0.5A Step-Down Voltage Regulator (JAPANESE)	605 Kbytes		<input type="checkbox"/> View Online	<input type="checkbox"/> Download	<input type="checkbox"/> Receive via

If you have trouble printing or viewing PDF file(s), see [Printing Problems](#).

Package Availability, Models, Samples & Pricing

Part Number	Package			Status	Models		Samples & Electronic Orders	Budgetary Pricing		Std Pack Size	Package Marking
	Type	Pins	MSL		SPICE	IBIS		Qty	\$US each		
LM2574HVM-12	SOIC WIDE	14	MSL	Full production	N/A	N/A	24 Hour Buy Now	1K+	\$2.0500	rail of 50	[logo]cUcZc2cT LM2574HVM -12 P+
LM2574HVM-15	SOIC WIDE	14	MSL	Full production	N/A	N/A	Samples Buy Now	1K+	\$2.0500	rail of 50	[logo]cUcZc2cT LM2574HVM -15 P+
LM2574HVM-3.3	SOIC WIDE	14	MSL	Full production	N/A	N/A	24 Hour Buy Now	1K+	\$2.0500	rail of 50	[logo]cUcZc2cT LM2574HVM -3.3 P+
LM2574HVM-5.0	SOIC WIDE	14	MSL	Full production	N/A	N/A	24 Hour Buy Now	1K+	\$2.0500	rail of 50	[logo]cUcZc2cT LM2574HVM -5.0 P+
LM2574HVM-ADJ	SOIC WIDE	14	MSL	Full production	N/A	N/A	24 Hour Buy Now	1K+	\$2.0500	rail of 50	[logo]cUcZc2cT LM2574HVM -ADJ P+
LM2574HVMX-12	SOIC WIDE	14	MSL	Full production	N/A	N/A	Buy Now	1K+	\$2.0500	reel of 1000	[logo]cUcZc2cT LM2574HVM -12 P+
LM2574HVMX-15	SOIC WIDE	14	MSL	Full production	N/A	N/A		1K+	\$2.0500	reel of 1000	[logo]cUcZc2cT LM2574HVM -15 P+
LM2574HVMX-3.3	SOIC WIDE	14	MSL	Full production	N/A	N/A		1K+	\$2.0500	reel of 1000	[logo]cUcZc2cT LM2574HVM -3.3 P+
LM2574HVMX-5.0	SOIC WIDE	14	MSL	Full production	N/A	N/A	Buy Now	1K+	\$2.0500	reel of 1000	[logo]cUcZc2cT LM2574HVM -5.0 P+
LM2574HVMX-ADJ	SOIC WIDE	14	MSL	Full production	N/A	N/A	Buy Now	1K+	\$2.0500	reel of 1000	[logo]cUcZc2cT LM2574HVM -ADJ P+
LM2574HVN-12	MDIP	8	MSL	Full production	N/A	N/A	24 Hour Buy Now	1K+	\$2.0500	rail of 40	[logo]cUcZc2cT LM2574HVN -12 P+
LM2574HVN-15	MDIP	8	MSL	Full production	N/A	N/A	Samples Buy Now	1K+	\$2.0500	rail of 40	[logo]cUcZc2cT LM2574HVN -15 P+
LM2574HVN-3.3	MDIP	8	MSL	Full production	N/A	N/A	24 Hour Buy Now	1K+	\$2.0500	rail of 40	[logo]cUcZc2cT LM2574HVN -3.3 P+
LM2574HVN-5.0	MDIP	8	MSL	Full production	N/A	N/A	24 Hour Buy Now	1K+	\$2.0500	rail of 40	[logo]cUcZc2cT LM2574HVN -5.0 P+

LM2574HVN-ADJ	MDIP	8	MSL	Full production	N/A	N/A	24 Hour Buy Now	1K+	\$2.0500	rail of 40	[logo]cUcZc2cT LM2574HVN -ADJ P+
LM2574HV-5 MDC	Die			Full production	N/A	N/A				tray of N/A	-
LM2574HV-5 MWC	Wafer			Full production	N/A	N/A				wafer jar of N/A	-

General Description

The LM2574 series of regulators are monolithic integrated circuits that provide all the active functions for a step-down (buck) switching regulator, capable of driving a 0.5A load with excellent line and load regulation. These devices are available in fixed output voltages of 3.3V, 5V, 12V, 15V, and an adjustable output version.

Requiring a minimum number of external components, these regulators are simple to use and include internal frequency compensation and a fixed-frequency oscillator.

The LM2574 series offers a high-efficiency replacement for popular three-terminal linear regulators. Because of its high efficiency, the copper traces on the printed circuit board are normally the only heat sinking needed.

A standard series of inductors optimized for use with the LM2574 are available from several different manufacturers. This feature greatly simplifies the design of switch-mode power supplies.

Other features include a guaranteed $\pm 4\%$ tolerance on output voltage within specified input voltages and output load conditions, and $\pm 10\%$ on the oscillator frequency. External shutdown is included, featuring 50 μA (typical) standby current. The output switch includes cycle-by-cycle current limiting, as well as thermal shutdown for full protection under fault conditions.

Features

- 3.3V, 5V, 12V, 15V, and adjustable output versions
- Adjustable version output voltage range, 1.23V to 37V (57V for HV version) $\pm 4\%$ max over line and load conditions
- Guaranteed 0.5A output current
- Wide input voltage range, 40V, up to 60V for HV version
- Requires only 4 external components
- 52 kHz fixed frequency internal oscillator
- TTL shutdown capability, low power standby mode
- High efficiency
- Uses readily available standard inductors
- Thermal shutdown and current limit protection

Applications

- Simple high-efficiency step-down (buck) regulator
- Efficient pre-regulator for linear regulators
- On-card switching regulators
- Positive to negative converter (Buck-Boost)

Application Notes

Title	Size in Kbytes	Date	<input type="checkbox"/> View Online	<input type="checkbox"/> Download	<input type="checkbox"/> Receive via Email
AN-1061: AN-1061 Power Conversion in Line-Powered Equipment	142 Kbytes	5-Jan-97	View Online	Download	Receive via Email
AN-1229: Application Note 1229 SIMPLE SWITCHER PCB Layout Guidelines	229 Kbytes	29-Jul-02	View Online	Download	Receive via Email

If you have trouble printing or viewing PDF file(s), see [Printing Problems](#).

[Information as of 5-Aug-2002]

[Search](#) **[Design](#)** **[Purchasing](#)** **[Quality](#)** **[Company](#)** **[Home](#)**

[About Languages](#) . [Website Guide](#) . [About "Cookies"](#) . National is [QS 9000 Certified](#) . [Privacy/Security Statement](#) . [Contact Us](#) . [Site Terms & Conditions of Use](#) . Copyright 2002 © National Semiconductor Corporation . [My Preferences](#) . **[Feedback](#)**